

# Panasonic

Personal Facsimile

Model No. **KX-F2581NZ**

Telephone Answering System with  
Facsimile

Model No. **KX-F2781NZ**

# OPERATING INSTRUCTIONS

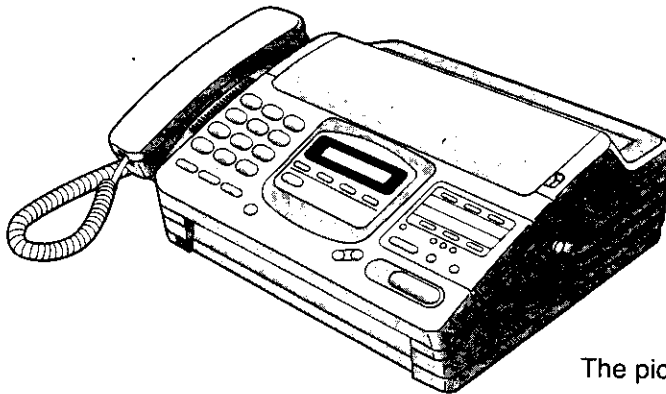

The pictured model is KX-F2781NZ.

## Contents

Installation and Connection . . . .	p. 6
Initial Preparation . . . . .	p. 12
Basic Operations . . . . .	p. 19
Advanced Operations . . . . .	p. 34
Troubleshooting and Routine Care . . . . .	p. 72
General Information . . . . .	p. 79

Please read these Operating Instructions before using the unit and save for future reference.

Thank you for purchasing the Panasonic Facsimile.

**For your future reference**

Date of purchase _____	Serial No. _____ (found on the bottom of the unit)
Dealer's name and address _____	
Dealer's telephone number _____	

**WARNING**

WHEN A FAILURE OCCURS WHICH RESULTS IN THE INTERNAL PARTS BECOMING ACCESSIBLE, DISCONNECT THE POWER SUPPLY CORD IMMEDIATELY AND RETURN THIS UNIT TO AN AUTHORIZED SERVICE CENTER.

DISCONNECT THE TELECOM CONNECTION BEFORE DISCONNECTING THE POWER CONNECTION PRIOR TO RELOCATING THE EQUIPMENT, AND RECONNECT THE POWER FIRST.

NO "111" OR OTHER CALLS CAN BE MADE FROM THIS DEVICE DURING A MAINS POWER FAILURE.

**Note:**



- A suffix "NZ" in the model number is omitted in these instructions.
- Most figures in these operating instructions are drawn on the basis of KX-F2581.

**Copyright:**

This manual is copyrighted by Kyushu Matsushita Electric Co., Ltd. (KME) and its licensee. Under the copyright laws, this manual may not be reproduced in any form, in whole or part, without the prior written consent of KME and its licensee.

© Kyushu Matsushita Electric Co., Ltd. 1997

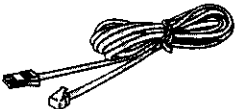
**Included accessories**

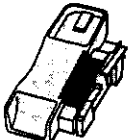
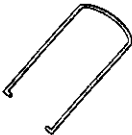
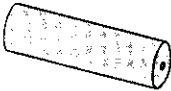
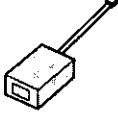
Power cord ..... 1 pc. (p. 11) 	Telephone line cord ..... 1 pc. (p. 11) 	Handset ..... 1 pc. (p. 9) 	Handset cord ..... 1 pc. (p. 9) 
Handset cradle .... 1 pc. (p. 9) 	Paper stacker .... 1 pc. (p. 10) 	Recording paper .. 1 pc. (p. 10) 	<b>For KX-F2581 only</b> Extension telephone adaptor ..... 1 pc. (p. 46) 

- If any items are missing, check with place of purchase.
- Save the original carton and packaging.

# Important safety instructions

When using this product, basic safety precautions should always be followed to reduce the risk of fire, electric shock, and injury to persons, including the following:

1. Read and understand all instructions.
2. Follow all warnings and instructions marked on this product.
3. Unplug this product from wall outlets before cleaning. Do not use liquid or aerosol cleaners. Use a damp cloth for cleaning.
4. Do not use this product near water, for example, near a bath tub, wash bowl, kitchen sink, or laundry tub, in a wet basement, or near a swimming pool.
5. Do not place this product on an unstable cart, stand or table. The product may fall, causing serious damage to the product or personal injury.
6. Slots and openings in the cabinet and the back or bottom are provided for ventilation, to protect it from overheating. These openings must not be blocked or covered. The openings should never be blocked by placing the product on the bed, sofa rug, or other similar surface. This product should never be placed near or over a radiator or heat register. This product should not be placed in a built-in installation unless proper ventilation is provided.
7. This product should be operated only from the type of power source indicated on the marking label. If you are not sure of the type of power supplied to your home, consult your dealer or local power company.
8. This product is equipped with a three wire grounding type plug, a plug having a third (grounding) pin. This plug will only fit into a grounding type power outlet. This is a safety feature. If you are unable to insert the plug into the outlet, contact your electrician to replace your obsolete outlet. Do not defeat the safety purpose of the grounding type plug.
9. Do not allow anything to rest on the power cord. Do not locate this product where the cord could be damaged by people walking on it.
10. Do not overload wall outlets and extension cords as this can result in the risk of fire or electric shock.
11. Never push objects of any kind into this product through cabinet slots as they may touch dangerous voltage points or short out parts that could result in a risk of fire or electric shock. Never spill liquid of any kind on the product.
12. To reduce the risk of electric shock, do not disassemble this product, but take it to an authorized service center when some service or repair work is required. Opening or removing covers may expose you to dangerous voltages or other risks. Incorrect reassembly can cause electric shock when the appliance is subsequently used.

13. Unplug this product from the wall outlet and refer servicing to an authorized service center under the following conditions:
  - A. When the power supply cord or plug is damaged or frayed.
  - B. If liquid has been spilled into the product.
  - C. If the product has been exposed to rain or water.
  - D. If the product does not work normally by following the operating instructions. Adjust only those controls, that are covered by the operating instructions because improper adjustment of other controls may result in damage and will often require extensive work by an authorized technician to restore the product to normal operation.
  - E. If the product has been dropped or the cabinet has been damaged.
  - F. If the product exhibits a distinct change in performance.
14. Avoid using a telephone (other than a cordless type) during an electrical storm. There may be a remote risk of electric shock from lightning.
15. Do not use the telephone to report a gas leak in the vicinity of the leak.

## SAVE THESE INSTRUCTIONS

### INSTALLATION:

1. Never install telephone wiring during a lightning storm.
2. Never install telephone jacks in wet locations unless the jack is specifically designed for wet locations.
3. Never touch uninsulated telephone wires or terminals unless the telephone line has been disconnected at the network interface.
4. Use caution when installing or modifying telephone lines.

### WARNING:

To prevent the risk of fire or electrical shock, do not expose this product to rain or any type of moisture.

### OTHER INFORMATION

- Keep the unit away from electrical noise-generating devices, such as fluorescent lamps and motors.
- The unit should be kept free from dust, moisture, high temperature, and vibration.
- The unit should not be exposed to direct sunlight.
- Do not place heavy objects on top of this unit.
- Do not damage the power cord.
- Do not touch the plug with wet hands.
- Do not use benzine, thinner, or any abrasive powder, to clean the cabinet. Wipe it with a soft cloth.

# Table of Contents

## Installation and Connection

Location of controls .....	6
Installing your unit .....	9
Connections .....	11

## Initial Preparation

Setting the date, time, logo and facsimile telephone number .....	12
Adjusting volumes .....	15
Selecting the receive mode .....	16

## Basic Operations

Making voice calls .....	19
Answering voice calls .....	19
Transmitting documents .....	20
Receiving documents .....	23
Making a copy .....	30
Operating the answering device (KX-F2781 only) .....	31

## Advanced Operations

### *Automatic dialing*

Storing phone numbers for automatic dialing .....	34
Making voice calls using automatic dialing .....	35
Transmitting documents using automatic dialing .....	35
Electronic telephone directory .....	36

### *Telephone*

Voice contact (talking to the caller during or after fax reception or transmission) ..	37
TONE, RECALL and REDIAL/PAUSE buttons .....	38

### *Facsimile*

Polling (retrieving fax documents) .....	39
Delayed transmission (sending a fax at a later time) .....	40
Sending documents overseas .....	41
Changing the logo print position .....	41
Remote fax receiving (using an extension to receive a fax message) .....	42
Junk mail prohibitor (preventing the reception of unwanted fax documents) .....	43
Receiving with distinctive ring service (FaxAbility) .....	44
Signaling your pager that you have received a fax document .....	45

<b>Using EXT.TAM mode (KX-F2581 only)</b>	
Using an external telephone answering machine .....	46
<b>Answering system (KX-F2781 only)</b>	
Voice mailbox (how callers can leave you private messages) .....	50
Transferring incoming calls .....	53
Operating the answering device from a remote phone .....	55
Recording your own greeting messages .....	60
Changing the caller's recording time .....	62
Setting the message alert .....	62
Setting the recording time alert .....	63
Changing the recording time for the ANS/FAX greeting message .....	63
<b>Others</b>	
Setting the friendly reception .....	64
Setting the fax voice guidance (KX-F2781 only) .....	64
Changing the display contrast .....	65
Setting the handset switch .....	65
Resetting the advanced features .....	66
Summary of user programmable features .....	67
Printing reports and lists .....	69

## Troubleshooting and Routine Care

Error messages on the display .....	72
Before requesting help .....	73
Clearing a recording paper jam .....	76
Clearing a document jam .....	77
Adjusting the feeder pressure .....	77
Removing the handset cradle .....	78
Cleaning the inside of the unit .....	78

## General Information

Specifications .....	79
Index .....	80
One-touch dialer list/Speed dialer list .....	81

# Location of controls

---

## Front view

---

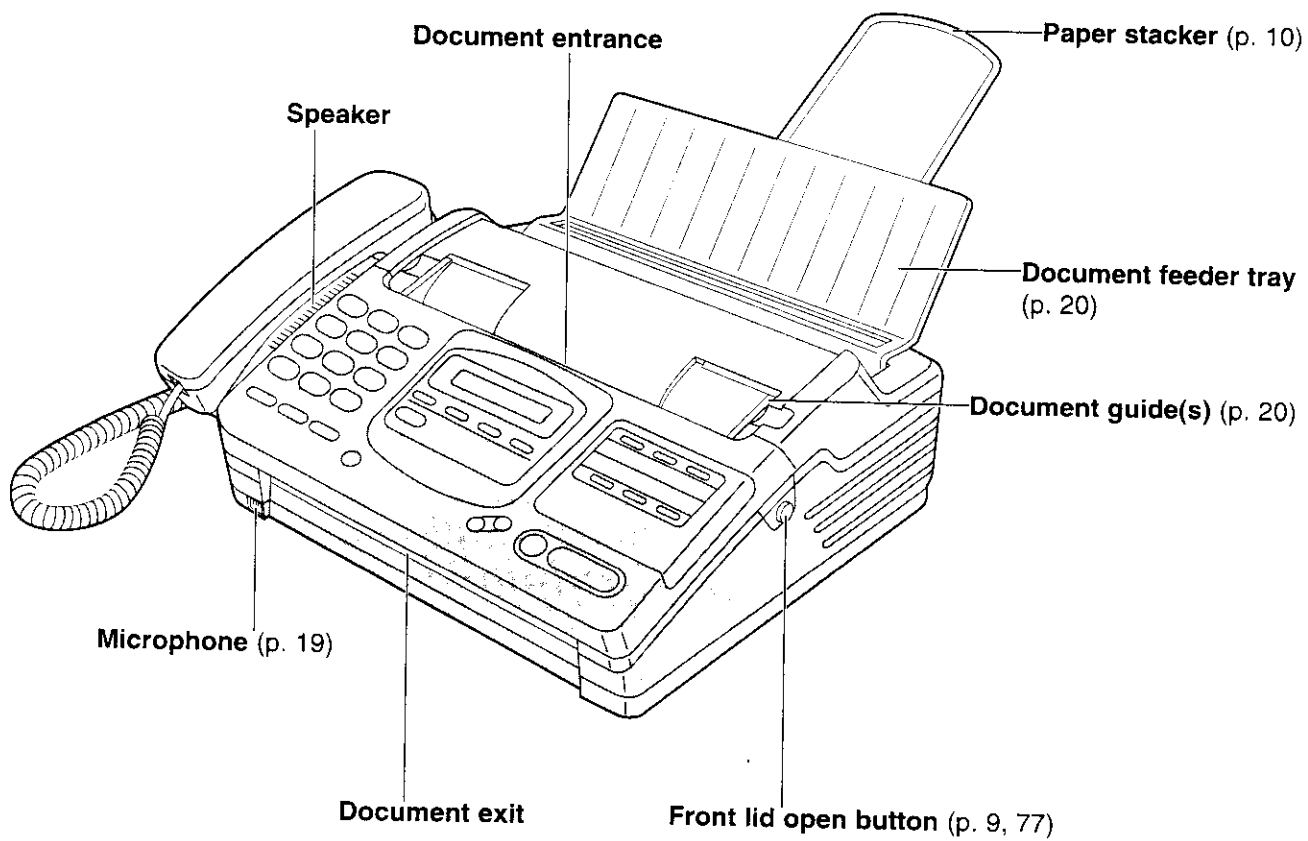

# Control panel (KX-F2581)

Installation and Connection

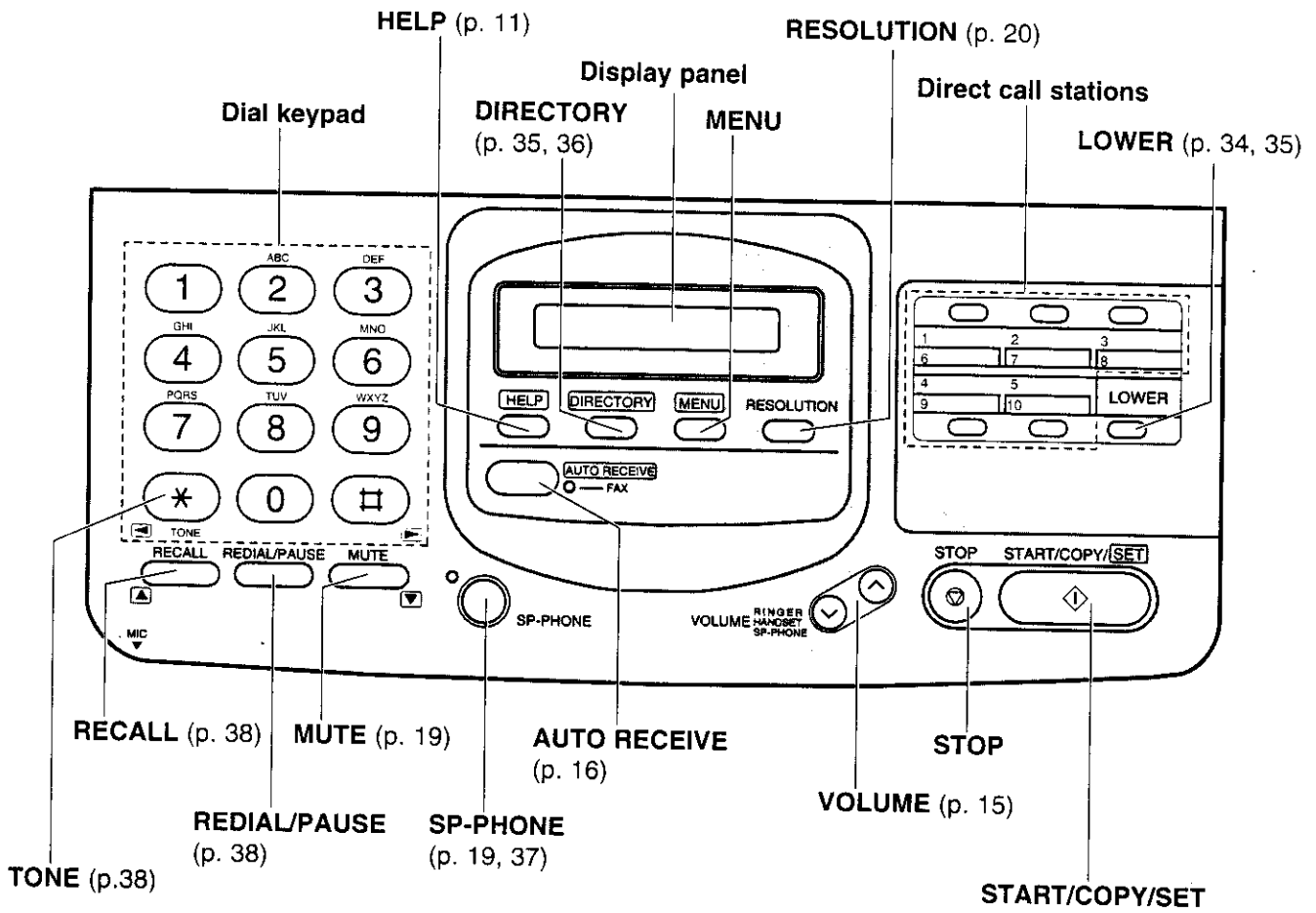

# Control panel (KX-F2781)

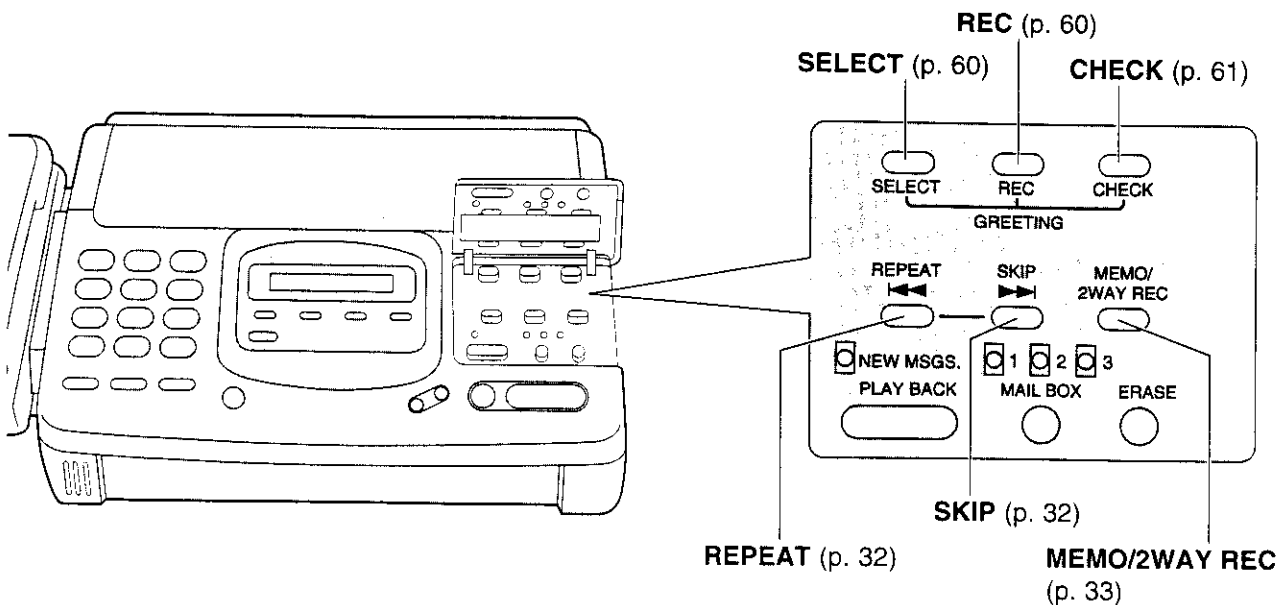
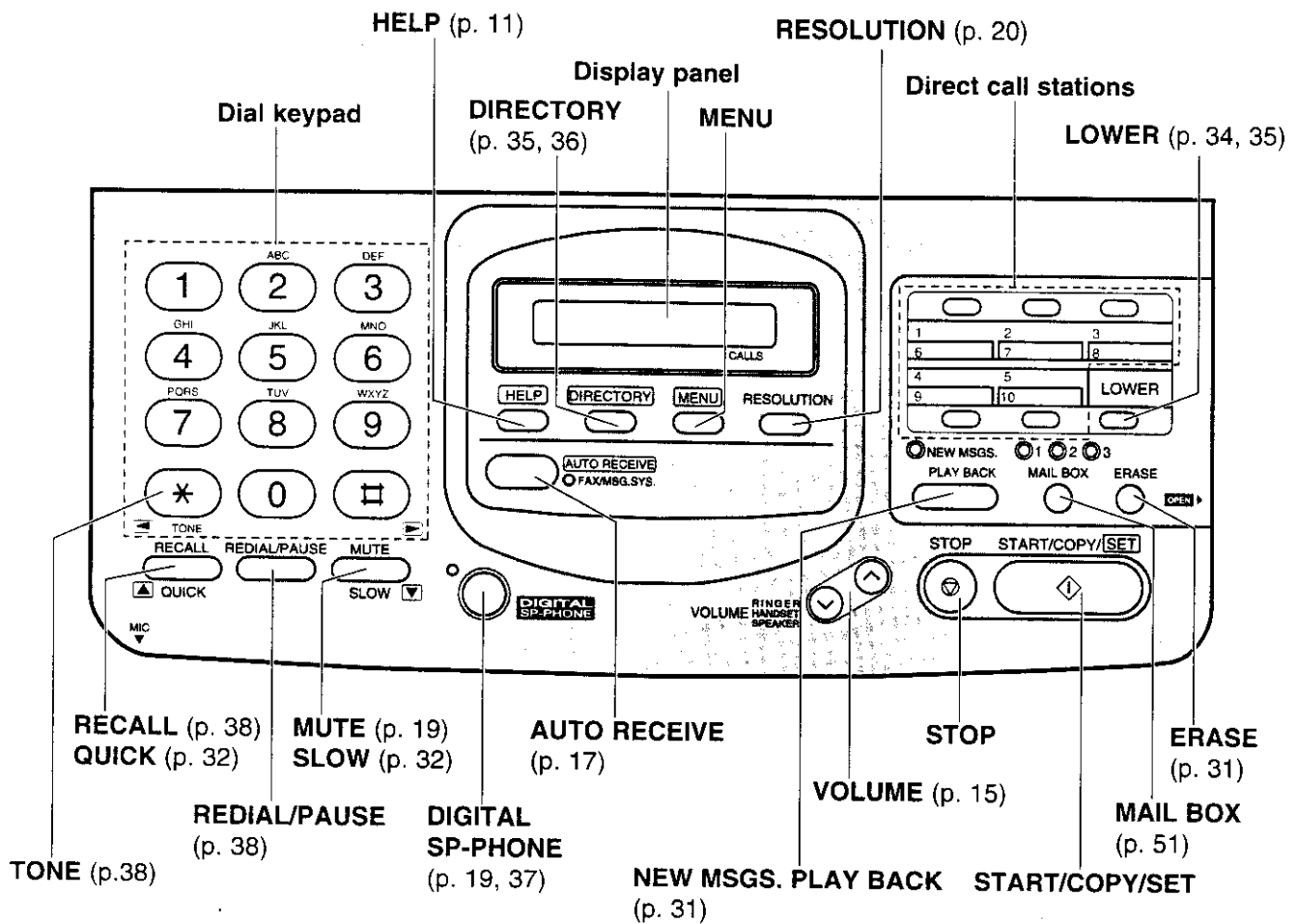



# Installing your unit

## Installing the handset cradle

If you want to use this unit with a handset, install the handset and handset cradle.

- To save space or to use the unit mainly for faxes, you may remove the handset cradle.
- Even if the handset and handset cradle are not installed, you can make or answer calls using the SP-PHONE button. When you do not use the handset and handset cradle, see pages 65 and 78.

**1** Connect the handset cord.

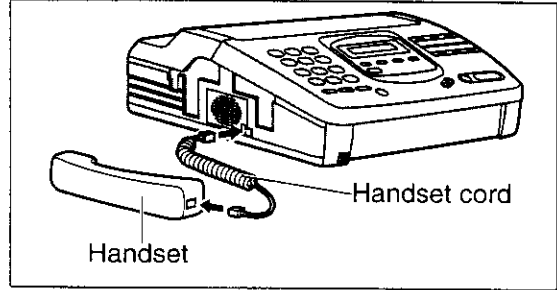

**2** (A) Open the front lid by pressing the front lid open button.  
 (B) Open the back lid by lifting up the tabs located on both sides.

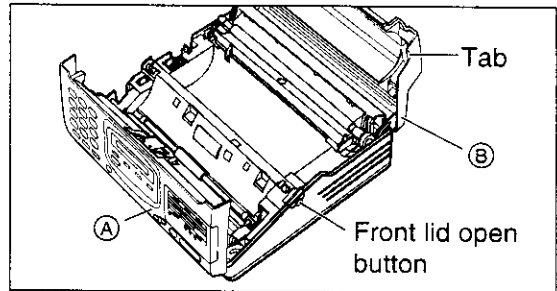

**3** Insert the handset cradle by matching the triangles.

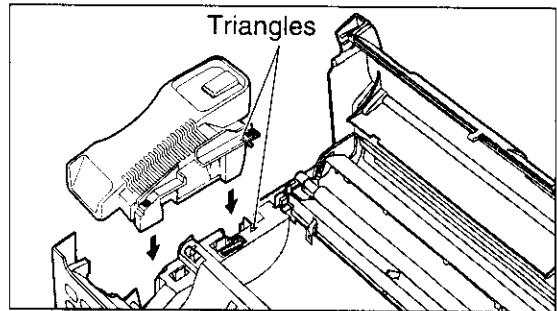

**4** Press down on the  marked on the handset cradle until it clicks into place.  
 • Make sure the two hooks lock the handset cradle firmly.

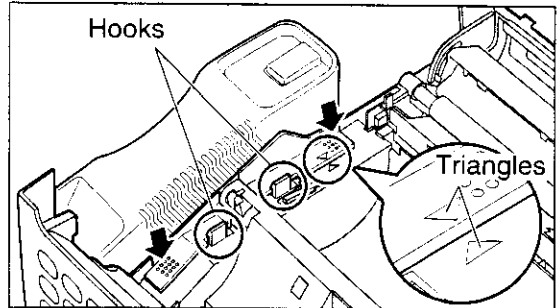

**5** Place the handset on the handset cradle and close the lids securely.  
 • If the following message is displayed when the unit is turned on, the handset cradle is not installed correctly.

CHECK CRADLE

Check step 4 again.

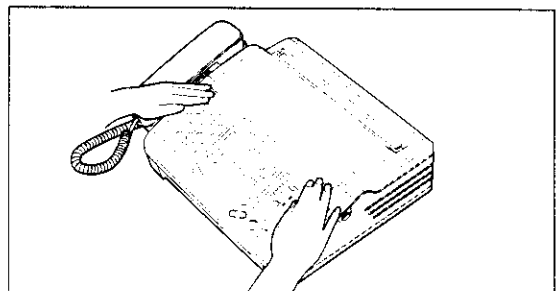

## Installing the recording paper

- 1
  - A Open the back lid by lifting up the tabs located on both sides.
  - B Install a recording paper roll in the unit.
    - Make sure that the shiny side of the paper is facing down and there is no slack, tape, or glue residue on the paper roll.

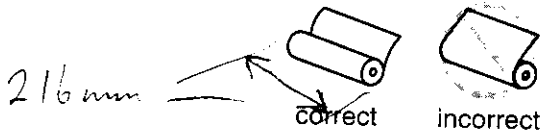

- 2 Insert the leading edge of the recording paper between the recording paper roller and the silver plate.

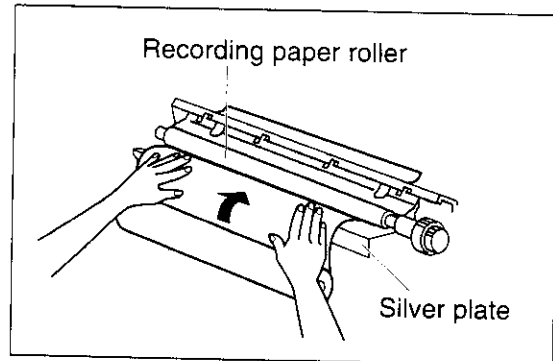
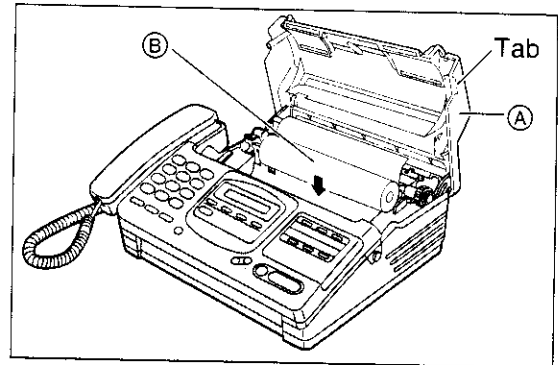

- 3 Close the back lid by gently pressing down on both ends.

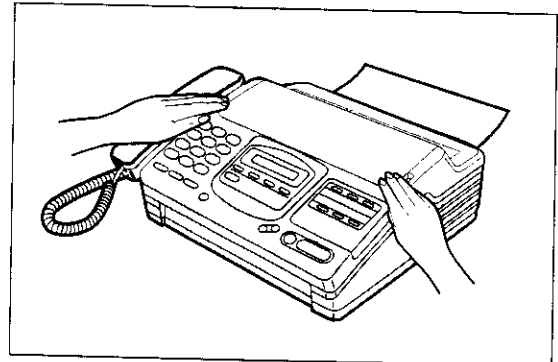

### Note:

- Only use the included roll of paper or specified recording paper, or else the print quality may be affected and/or excessive thermal head wear may occur.
- The beginning of some recording paper rolls are secured with glue or tape. Cut approximately 150 mm (6 inches) from the new roll of paper prior to installation.

## Installing the paper stacker

Install the paper stacker.

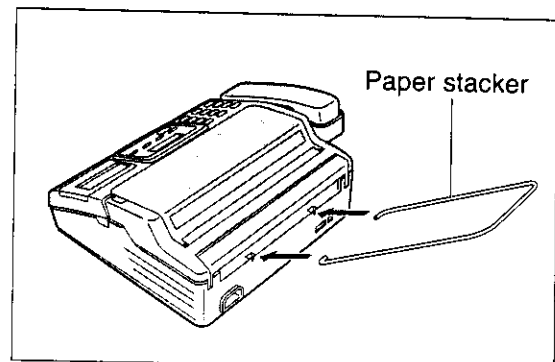

# Connections

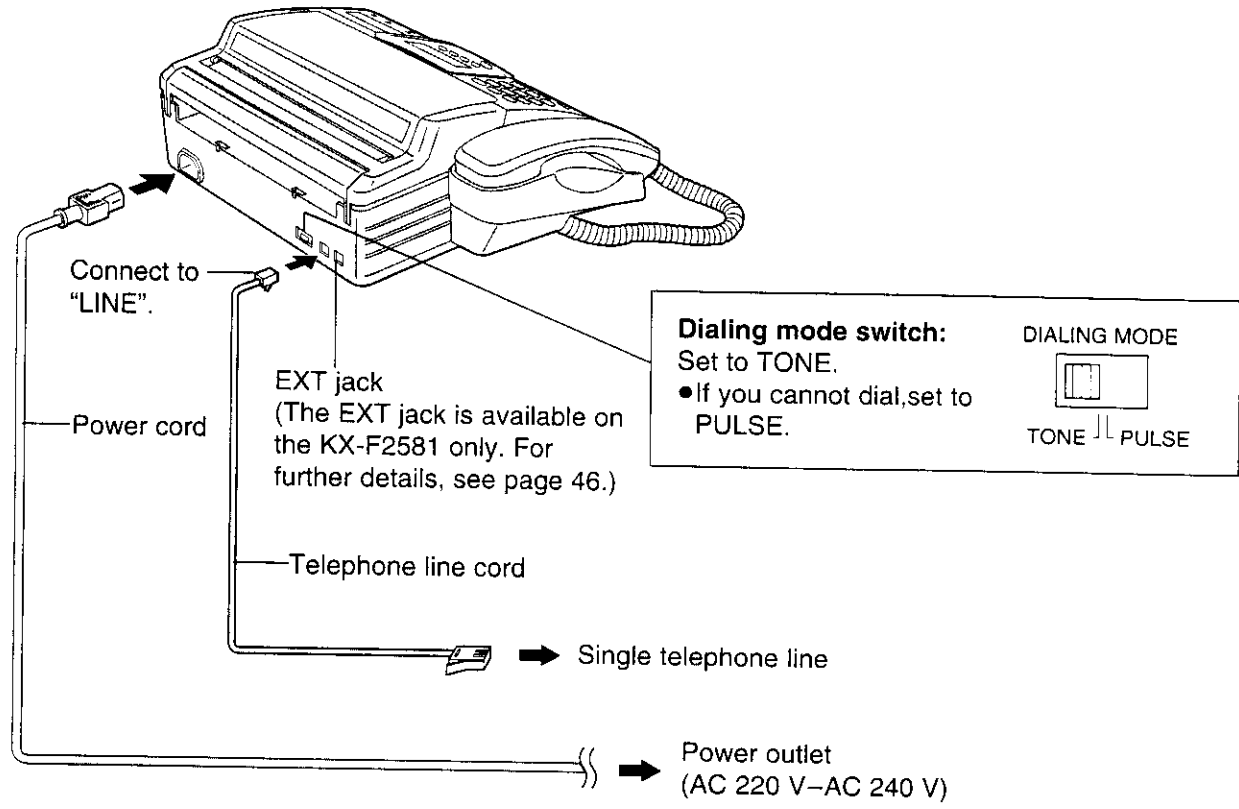

**Note:**

- When you operate this product, the power outlet should be near the product and easily accessible.
- When you connect another telephone on the same line and if the decadic (pulse) signalling option is used, bell tinkle may occur during dialing. If this occurs, the matter should be discussed with the telephone supplier and should NOT be referred to Telecom Faults Service.
- Not all standard telephones will respond to incoming ringing when connected to the same line or the external telephone jack (EXT.).

**Helpful hint:**

- If assistance is needed, press **HELP**. The unit will print a quick reference.

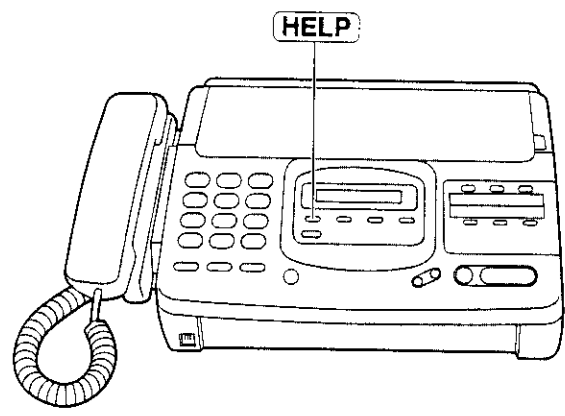

# Setting the date, time, logo and facsimile telephone number

Before using your unit, program the correct date and time, your logo and your facsimile telephone number.

This information will be printed on the top of each page transmitted from your unit.  
To change the print position, see page 41.

## Setting the date and time

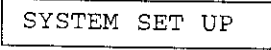
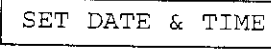

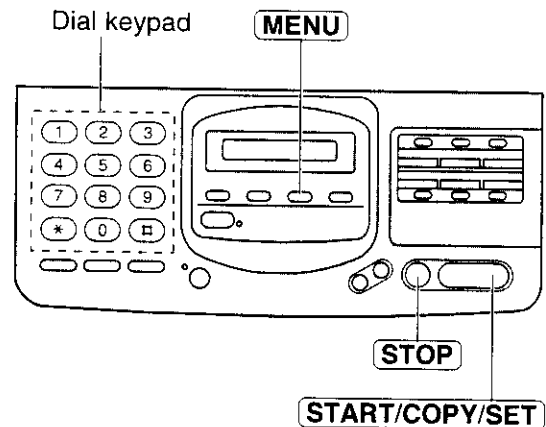
- 1 Press **MENU**.  

- 2 Press **#**, then **0 1**.  

- 3 Press **START/COPY/SET**.
- 4 Enter the correct month/day/year/hour/minute by selecting each 2 digits.  
Then press **\*** for AM or **#** for PM.  
**Example:** Aug. 10 1997, 3:00PM  
Press **0 8 1 0 9 7 0 3 0 0**,  
then press **#** for PM.
- 5 Press **START/COPY/SET**.
- 6 Press **MENU**.

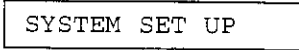
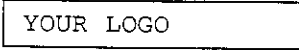

- Note:**
- If you make a mistake while programming, press **STOP** then make corrections.
  - The accuracy of the clock will be approximately  $\pm 60$  seconds a month.

## Setting your logo

Usually the logo is a company, division or personal name in an abbreviated form.

- 1 Press **MENU**.  

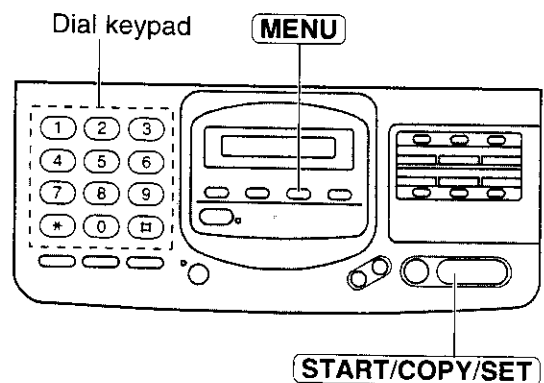
- 2 Press **#**, then **0 2**.  

- 3 Press **START/COPY/SET**.  

- 4 Enter your logo up to 30 characters.  
• Refer to the instructions on page 13.
- 5 Press **START/COPY/SET**.
- 6 Press **MENU**.



# How to enter characters and symbols

The dial keypad and the direct call stations can be used as character input keys and command keys. Pressing 0-9 and direct call station 1 will alternately select a character as shown below.

Keys	Number of times												
	1	2	3	4	5	6	7	8	9	10	11	12	13
1	1	[	]	{	}	+	-	/	=	,	.	-	'
2	A	B	C	a	b	c	2						
3	D	E	F	d	e	f	3						
4	G	H	I	g	h	i	4						
5	J	K	L	j	k	l	5						
6	M	N	O	m	n	o	6						
7	P	Q	R	S	p	q	r	s	7				
8	T	U	V	t	u	v	8						
9	W	X	Y	Z	w	x	y	z	9				
0	0	(	)	<	>	!	"	#	\$	%	&	¥	
	:	;	?		*	@	^	'	→				
	INSERT key (Used to insert one character or one space.)												
	SPACE key (Used to replace one character with a space.)												
	DELETE key (Used to delete one character.)												
	▶ key (Used to move the cursor to the right.)												
	◀ key (Used to move the cursor to the left.)												

Initial Preparation

For example, when entering "Mike" as your logo:

1 Press **6**.

LOGO=M

2 Press **4** six times.

LOGO=Mi

3 Press **5** five times.

LOGO=Mik

4 Press **3** five times.

LOGO=Mike

**Note:**

• If you use the same number key continuously to enter the next character, press **▶** to move the cursor.

## To correct a mistake while programming

Use **▶** and **◀** to move the cursor to the incorrect character, then make the correction.

or

Press **STOP** to delete the character to the left of the cursor.

## To see the layout of the direct call station keys

Remove the directory card cover with a pencil or similar object and turn the directory card over.

# Setting your facsimile telephone number \_\_\_\_\_

- 1 Press **MENU**.
- 2 Press **#**, then **0** **3**.
- 3 Press **START/COPY/SET**.
- 4 Enter your facsimile telephone number up to 20 digits.
  - The **#** button inserts a space and the **\*** button a "+".
  - Example:** +64 9 1234567
  - If you make a mistake, press **STOP** to delete the wrong number to the left of the cursor.
- 5 Press **START/COPY/SET**.
- 6 Press **MENU**.

SYSTEM SET UP

YOUR TEL NO.

NO. =

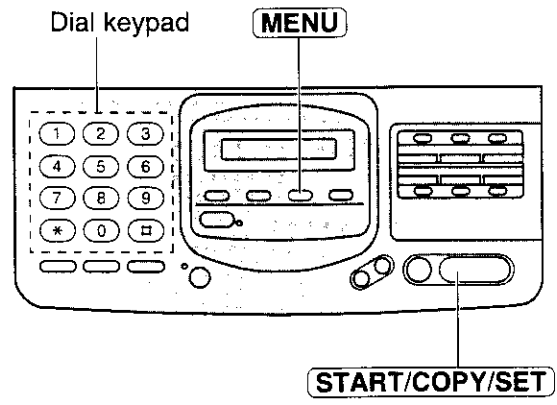

# Adjusting volumes

## ■ Ringer volume

Press **VOLUME** (v/∧) while the unit is idle.  
●3 levels (high/low/off) are available.

### To turn the ringer off:

1. Press **VOLUME** (v) repeatedly.  
●The following message will be shown.

RINGER OFF= OK?

2. Press **START/COPY/SET**.

### While the ringer volume is set to off:

The display will show the following message and the unit will not ring when receiving a call.

RINGER OFF

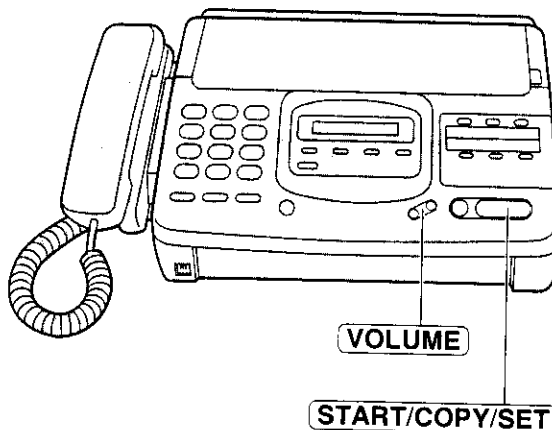

Initial Preparation

## ■ Handset volume

Press **VOLUME** (v/∧) while using the handset.  
●3 levels (high/middle/low) are available.

## ■ Speaker volume

Press **VOLUME** (v/∧) while using the speakerphone.  
●8 levels (high to low) are available.

## ■ Answering device volume (KX-F2781 only)

Press **VOLUME** (v/∧) while listening to recorded messages.  
●9 levels (high to off) are available.

## ■ Fax voice guidance volume (KX-F2781 only)

Press **VOLUME** (v/∧) while listening to the voice guidance.  
●9 levels (high to off) are available.

# Selecting the receive mode

## For KX-F2581

This unit has two types of receive modes; AUTO RECEIVE and MANUAL RECEIVE.

—When you are unable to answer, set the AUTO RECEIVE mode.

—When you are available, set the MANUAL RECEIVE mode.

Press **AUTO RECEIVE** to switch to the desired mode.

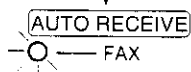
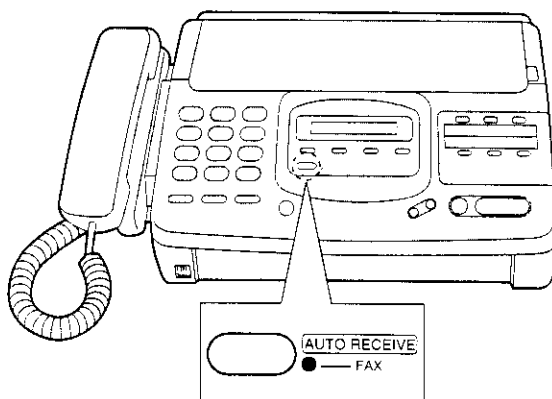

### ■ AUTO RECEIVE mode

The FAX indicator light goes on.

**FAX mode:** (pre-selected setting)  
Select this mode when you use the unit solely as a fax machine (see page 26).

**Display:** FAX MODE



- You can select the EXT.TAM mode instead of the FAX mode as an AUTO RECEIVE mode (page 18).

**EXT.TAM mode:**  
Select this mode when you connect a telephone answering machine to the external telephone (EXT) jack and leave the home or office (see pages 46 through 49).

- If your external telephone does not have an answering/recording feature, do not select this mode. We recommend that you select the TEL mode.

**Display:** EXT.TAM MODE

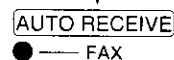

### ■ MANUAL RECEIVE mode

The FAX indicator light goes off.

**TEL mode:** (pre-selected setting)  
Select this mode when you wish to answer all calls manually.

**Display:** TEL MODE

- When no one answers an incoming call by 15 rings, the unit will temporarily activate the fax function to receive documents.



- You can select the TEL/FAX mode instead of the TEL mode as a MANUAL RECEIVE mode (page 18).

**TEL/FAX mode:**  
Select this mode when you are near the unit and do not want to hear the unit ring when faxes are received but wish to answer voice calls (see pages 27, 28 and 29).

**Display:** TEL/FAX MODE

#### Note:

- Regardless of the mode you select, you can always place calls and faxes.



# For KX-F2781

The unit combines the functions of facsimile, telephone and answering system. This unit has two types of receive modes; AUTO RECEIVE and MANUAL RECEIVE.  
—When you are unable to answer, set the AUTO RECEIVE mode.  
—When you are available, set the MANUAL RECEIVE mode.

Press **AUTO RECEIVE** to switch to the desired mode.

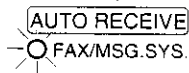
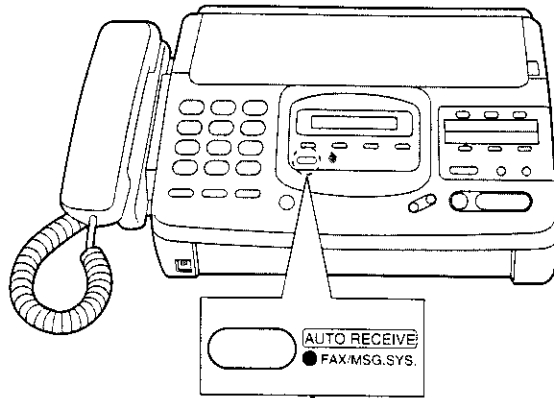

## ■ AUTO RECEIVE mode

The FAX/MSG.SYS. indicator light goes on.

**ANS/FAX mode:** (pre-selected setting)  
Select this mode when you want the unit to record voice messages and/or receive fax messages (see pages 24 and 25).

Display:

- You can select the FAX mode instead of the ANS/FAX mode as an AUTO RECEIVE mode (page 18).

**FAX mode:**  
Select this mode when you use the unit solely as a fax machine (see page 26).

Display:

### Note:

- Regardless of the mode you select, you can always place calls and faxes.

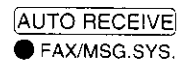

## ■ MANUAL RECEIVE mode

The FAX/MSG.SYS. indicator light goes off.

**TEL mode:** (pre-selected setting)  
Select this mode when you wish to answer all calls manually.

Display:

- You can change to the ANS/FAX mode from a remote location. Call your unit from a touch tone phone and wait for 15 rings. The answering system will temporarily answer the line. Then enter the remote operation ID (page 56) during the greeting message. The unit will switch to the ANS/FAX mode.

- You can select the TEL/FAX mode instead of the TEL mode as a MANUAL RECEIVE mode (page 18).





**TEL/FAX mode:**  
Select this mode when you are near the unit and do not want to hear the unit ring when faxes are received but wish to answer voice calls (see pages 27, 28 and 29).

Display:

## Changing the setting of the AUTO RECEIVE mode \_\_\_\_\_

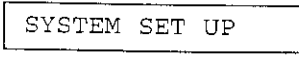
If your model is KX-F2581; Select either FAX mode (pre-selected setting) or EXT.TAM mode.  
If your model is KX-F2781; Select either ANS/FAX mode (pre-selected setting) or FAX mode.

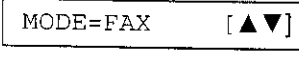
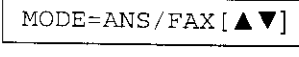
To change the setting, follow the steps below.



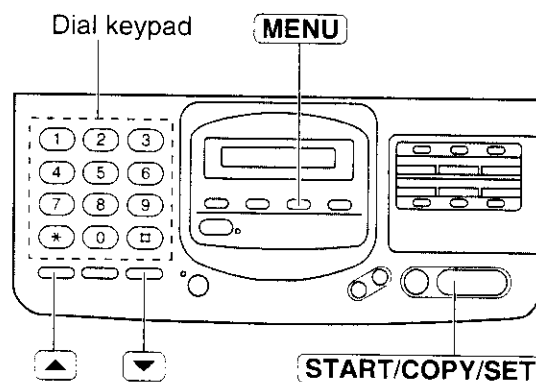

- 1 Press **MENU**.  

- 2 Press **#**, then **0** **5**.  

- 3 Press **START/COPY/SET**.  
KX-F2581:   
KX-F2781: 
- 4 Press  or  to select the desired setting.
- 5 Press **START/COPY/SET**.
- 6 Press **MENU**.

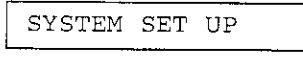
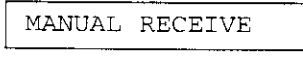

## Changing the setting of the MANUAL RECEIVE mode \_\_\_\_\_

Select either TEL mode (pre-selected setting) or TEL/FAX mode.

To change the setting, follow the steps below.

- 1 Press **MENU**.  

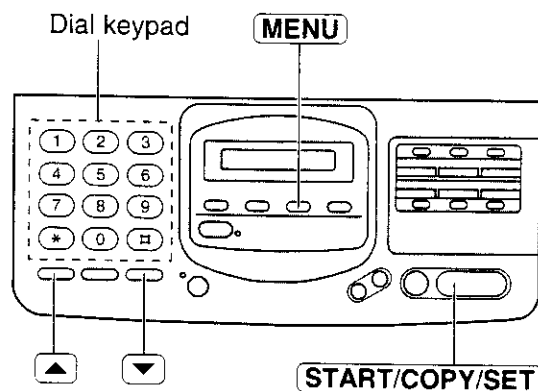
- 2 Press **#**, then **0** **8**.  

- 3 Press **START/COPY/SET**.  

- 4 Press  or  to select the desired setting.
- 5 Press **START/COPY/SET**.
- 6 Press **MENU**.

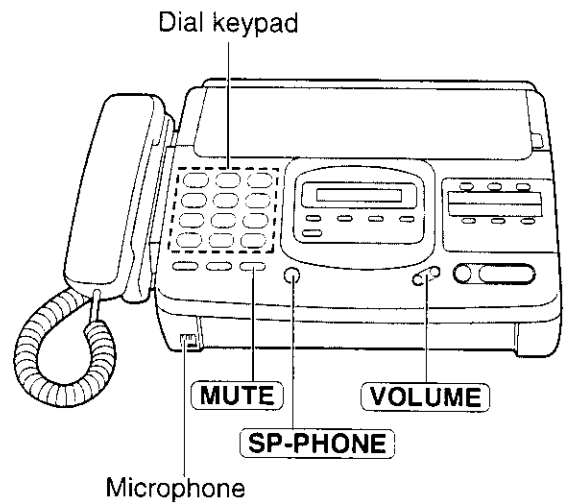

# Making voice calls

- 1 Press **SP-PHONE** or lift the handset.
- 2 Dial a phone number.
  - If you misdial, hang up and dial again.
- 3 When the other party answers, speak into the microphone or handset.
- 4 When finished, press **SP-PHONE** again or hang up the handset.



# Answering voice calls

- 1 When the unit rings, lift the handset or press **SP-PHONE**.
- 2 When finished, hang up the handset or press **SP-PHONE**.

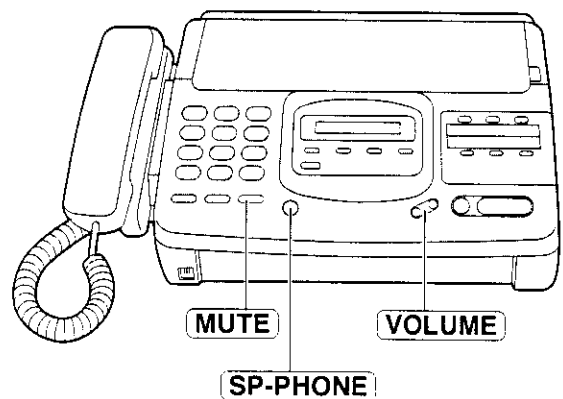

## Voice muting

Using this feature, the other party cannot hear you but you can hear them.

1. Press **MUTE** during a telephone conversation.

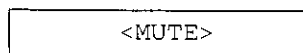

2. To resume the conversation, press **MUTE** again.

## Hints for speakerphone operation

- Use the speakerphone in a quiet room.
- If the other party has difficulty hearing you, adjust the volume using **VOLUME**.
- If you and the other party speak at the same time, parts of your conversation will be lost.
- To switch to the handset, lift the handset. To switch back to the speakerphone again, press **SP-PHONE**.

# Transmitting documents

## Documents you can send

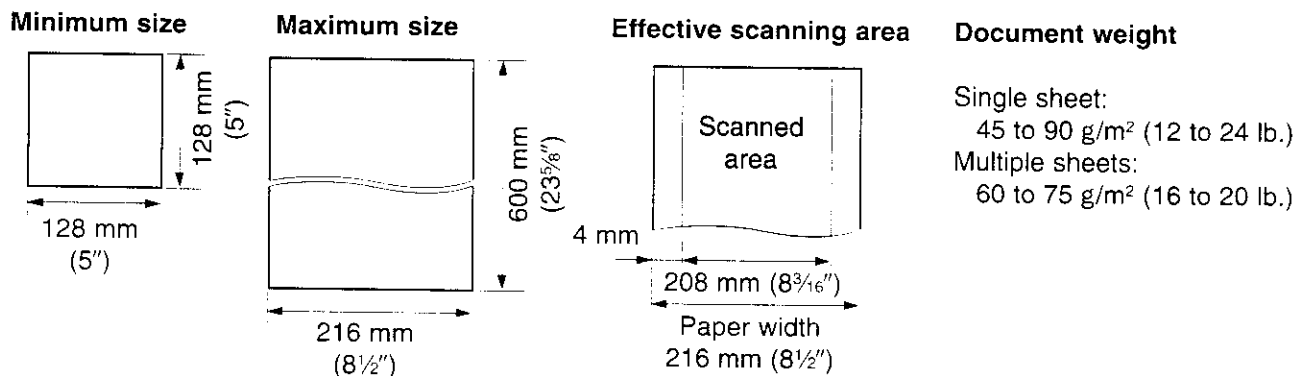

### Note:

- Remove clips, staples or other similar fastening objects.
- Check that ink, paste or correction fluid has dried.
- Do not send the following types of documents. Use copies for fax transmission.
  - Chemically treated paper such as carbon or carbonless duplicating paper
  - Electrostatically charged paper
  - Heavily curled, creased or torn paper
  - Paper with a coated surface
  - Paper with a faint image
  - Paper with printing on the opposite side that can be seen through the front (e.g. newspaper)

## Loading documents

- 1 Open the document feeder tray.
- 2 Insert the documents **FACE DOWN** until a beep tone is heard.
  - The unit can accept up to 15 sheets of paper at a time.
- 3 Adjust the document guides to the width of the document.
- 4 Press **RESOLUTION** repeatedly to the desired setting.

STANDARD	For printed or typewritten originals with normal-sized characters.
FINE	For originals with small printing.
SUPER FINE	For originals with minute printing.
HALF TONE	For originals containing photographs, shaded drawings, etc.

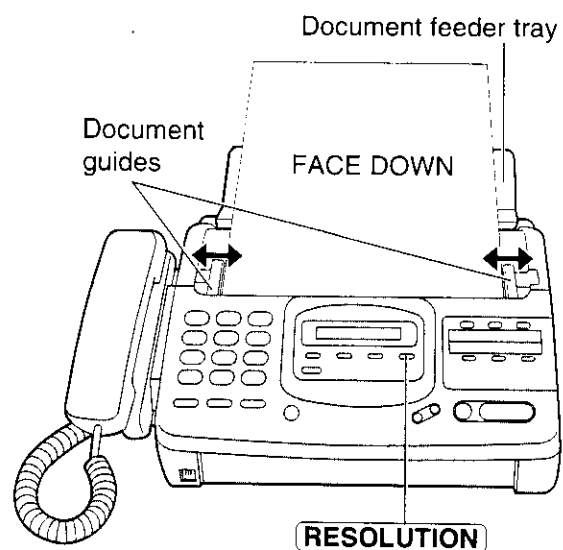

### Note:

- Using the fine, super fine or half tone setting will increase transmission time.
- If the resolution setting is changed during feeding, it will be effective from the next sheet.
- The super fine resolution only works with other compatible machines.

## Transmitting documents manually

- 1 Insert the documents **FACE DOWN** until a beep tone is heard.
- 2 Press **SP-PHONE** or lift the handset.
- 3 Dial a phone number.
  - If you misdial, hang up and dial again.
- 4 When a fax tone is heard, press **START/COPY/SET**.
- 5 Hang up the handset if using it.

### Note:

- If the other party answers your call, ask them to start receiving a fax, then press your **START/COPY/SET**.
- The unit will automatically end the transmission after the last sheet is transmitted.

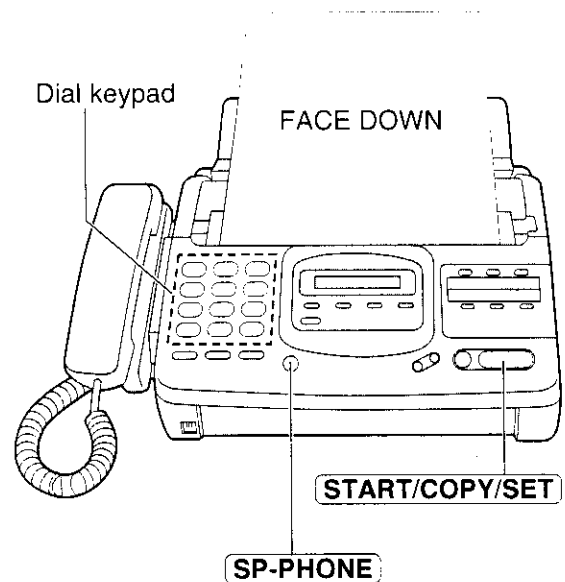

## Transmitting documents with fewer procedures

- 1 Insert the documents **FACE DOWN** until a beep tone is heard.
- 2 Dial a phone number.
  - If you misdial, press **STOP** and dial again.
- 3 Press **START/COPY/SET**.
  - The unit will start to dial and transmit the documents.

### Fax Auto Redial

- If there is no answer or the line is busy, the unit will automatically redial the number up to 2 times. This feature is available when;
  - documents with fewer procedures
  - automatic dialing (p. 35)
  - delayed transmission (p. 40)
  - receive polling (p. 39).To cancel redialing, press **STOP**.

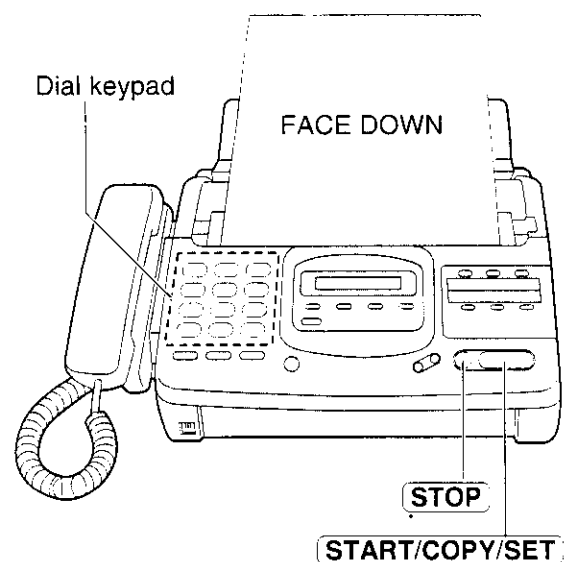

### To send 16 or more sheets at a time

Insert the first 15 sheets of the document. Add the extra sheets (up to 15) before the last sheet is fed into the unit.

### To stop transmission

Press **STOP**.

- To eject the document, press **STOP** again.

### Fax voice guidance about transmission (KX-F2781 only)

After transmission, one of the following messages will tell you the result.

- *Transmission is complete.*
- *Transmission has failed.*

You can set this feature to OFF and the guidance will not be heard (see page 64).

# Transmitting documents by following the voice guide (KX-F2781 only)

---

**1** Press **MENU** until the following is displayed.

XMT VOICE GUIDE

**2** Press **HELP**.

**Voice guide:**

*To transmit, insert the document face down until you hear the beep.*

**3** Insert the documents **FACE DOWN** until a beep tone is heard.

**Voice guide:**

*Press the speaker phone button, then dial the phone number. When the fax tone is heard, press the start button.*

**4** Press **DIGITAL SP-PHONE**.

**5** Dial a phone number.

**6** When a fax tone is heard, press **START/COPY/SET**.

**Voice guide:**

*Start transmission.*

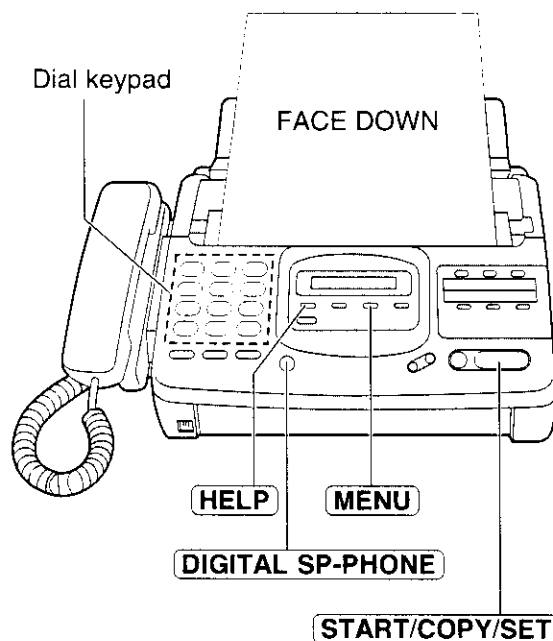

## Note:

- You can lift the handset instead of pressing **DIGITAL SP-PHONE** in step 4.

# Receiving documents

## Receiving fax documents manually

- 1 When the unit rings, lift the handset or press **SP-PHONE** to answer the call.
- 2 When:
  - document reception is required,
  - a slow beep is heard, or
  - no sound is heard,press **START/COPY/SET**.
- 3 Hang up the handset if using it.
  - The recording paper will print out face side down.

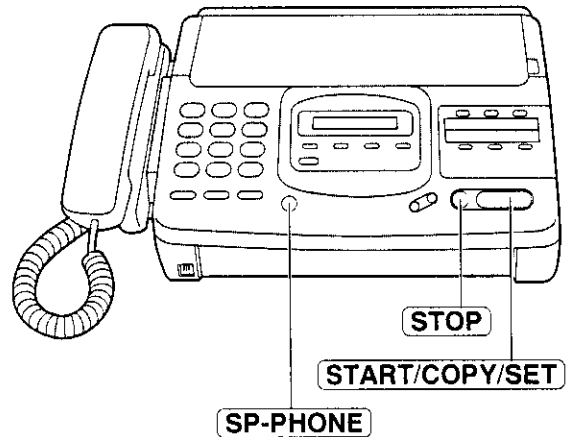

### Friendly reception

If you hear a slow beep when you answer a call, the unit will automatically start fax reception. You need not press **START/COPY/SET**. This is called "friendly reception".

- If the friendly reception feature is not required, set to OFF (see page 64).

If your model is KX-F2781 and the friendly reception is activated, one of the following voice messages will be heard.

- Please hang up the handset for reception.*
- Start reception.*
- If the fax voice guidance feature is set to OFF (see page 64), these messages will not be heard.

### Fax voice guidance about reception (KX-F2781 only)

After reception, one of the following messages will tell you the result.

- Reception is complete.*
- Reception has failed.*
- Reception has been interrupted.*

- You can set this feature to OFF and the guidance will not be heard (see page 64).

### Memory reception (KX-F2781 only)

The unit will temporarily store receive documents in memory when;

- the unit runs out of recording paper,
- the unit is overheated, or
- the recording paper is jammed.

To print a document, install a new recording paper roll, or let the unit cool down, or clear the jammed paper.

- If memory becomes full, the unit will stop receiving documents and the display will show the following message.

MEMORY FULL

- Concerning the memory capacity, see page 79.

### To stop reception

Press **STOP**.

# Receiving fax documents and/or recording incoming voice messages automatically (ANS/FAX mode—KX-F2781 only)

When you turn on the AUTO RECEIVE mode that is set to ANS/FAX, the unit will work as a facsimile machine and/or answering device.

If a fax call is detected, the unit will automatically switch to the fax and receive fax documents.

If a voice call is detected, the answering system will begin recording, then the caller can leave a voice message.

## Setup of voice message and document reception

The total recording time (including the greeting messages) is about 18 minutes when no fax documents are in memory. If messages are recorded in noisy rooms, the time may be shortened by 7 minutes.

To record incoming voice messages and receive fax documents, follow these steps:

**1** Make sure that the AUTO RECEIVE mode is set to ANS/FAX (see page 18).

**2** Turn on the AUTO RECEIVE mode by pressing **AUTO RECEIVE** until the FAX/MSG.SYS. indicator light goes on.

- The display shows the following message.

ANS/FAX MODE

- The remaining time for recording incoming messages will be displayed on the display.

**Example:** TIME LEFT=10m13s

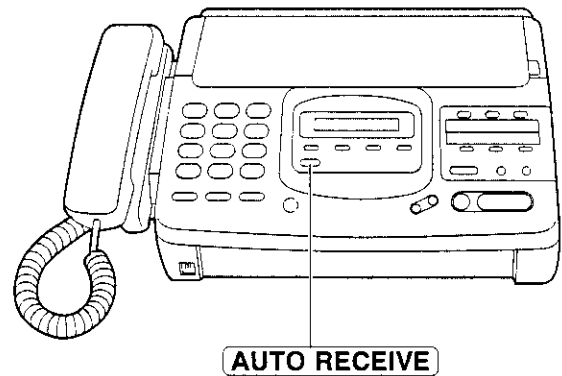

### Note:

- You can record your own greeting message (see page 60).
- Each incoming message recording time can be set to either unlimited or 1 minute. To change the setting, see page 62.
- When the remaining time is low, erase unnecessary messages from memory (see pages 31 and 52).

## Pre-recorded greeting messages

The unit has pre-recorded greeting messages in common memory. According to the unit's condition, one of the following pre-recorded greeting messages will be played to the caller.

- When your own greeting message (page 60) is not recorded, the following greeting message will be played.

*Hello! We are unable to answer right now.  
To send a fax, please start transmission.  
To leave a voice message, please speak after the beep.  
Thank you.*



- When the unit detects a problem, one of the following pre-recorded greeting messages will be played.

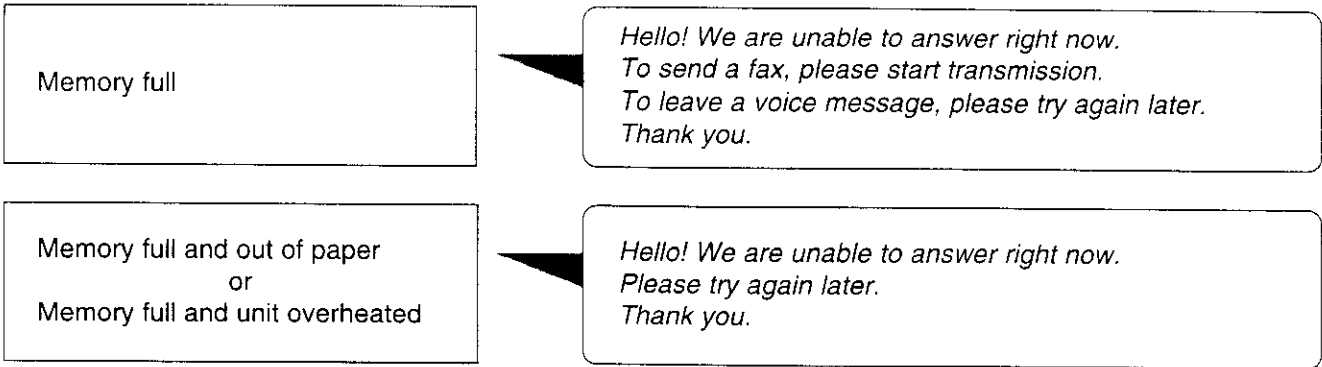

## Setting the ANS/FAX mode ring count

This feature determines the number of rings after which the unit answers a call in the ANS/FAX mode. You can choose from 2 to 9, TOLL SAVER and RINGER OFF.

**TOLL SAVER:** When you call the unit from a remote location, the number of rings will tell you if there are any new voice messages. If the unit answers on the second ring, there is at least one new recorded message. If the unit answers on the fourth ring, there are no new recorded messages. Hang up immediately when you hear the third ring. The third ring indicates that there are no new messages. This will save you the toll charge for the call.

**RINGER OFF:** The unit will answer without ringing.

### Helpful hints:

- To answer a call before the unit does, increase the number of rings.
- If you find difficulty in receiving faxes from machines that have an automatic transmission feature, decrease the number of rings.

- 1 Press **MENU**.
- 2 Press **#**, then **0** **6**.
- 3 Press **START/COPY/SET**.
- 4 Press **▲** or **▼** to select the desired setting.
- 5 Press **START/COPY/SET**.
- 6 Press **MENU**.

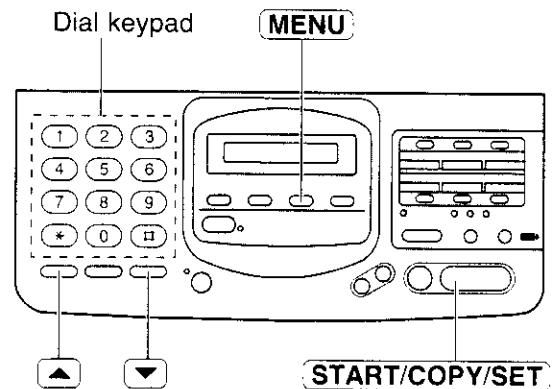

## Receiving fax documents only (FAX mode)

When you turn on the AUTO RECEIVE mode that is set to FAX, the unit will work as a dedicated facsimile machine.

The unit will automatically answer all calls and generate fax tones to the callers. Callers will hear fax tones and will only be able to transmit faxes.

### Setting up the unit for fax reception

- 1 Set the AUTO RECEIVE mode to FAX (see page 18).
- 2 Turn on the AUTO RECEIVE mode by pressing **AUTO RECEIVE** until the FAX or FAX/MSG.SYS. indicator light goes on.
  - The display shows the following message.

FAX MODE

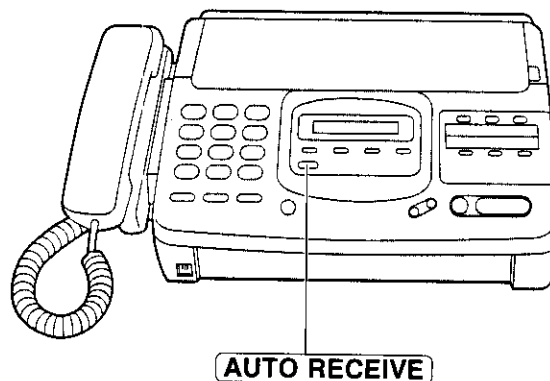

### Setting the FAX mode ring count

This feature determines the number of rings after which the unit answers a call in the FAX mode. You can choose from 2 to 9 rings.

#### Helpful hints:

- To answer a call before the unit does, increase the number of rings.
- If you find difficulty in receiving faxes from machines with an automatic transmission feature, decrease the number of rings.

- 1 Press **MENU**.  
SYSTEM SET UP
- 2 Press **#**, then **0** **7**.  
FAX RING
- 3 Press **START/COPY/SET**.  
RING=2 [▲▼]
- 4 Press **▲** or **▼** to select the desired number.
- 5 Press **START/COPY/SET**.
- 6 Press **MENU**.

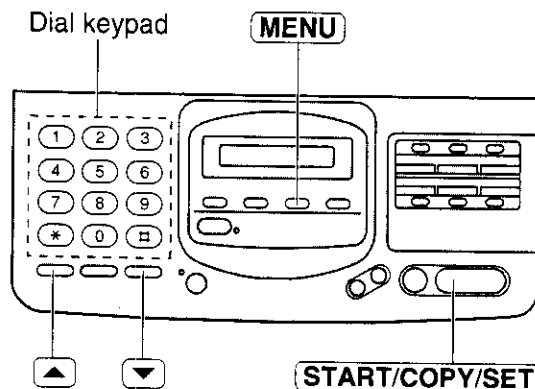

## Receiving both voice and fax calls (TEL/FAX mode)

Use this mode when you wish to receive voice calls with ring but do not want to hear the unit ring when faxes are received.

When a call is received, the unit will work as follows.

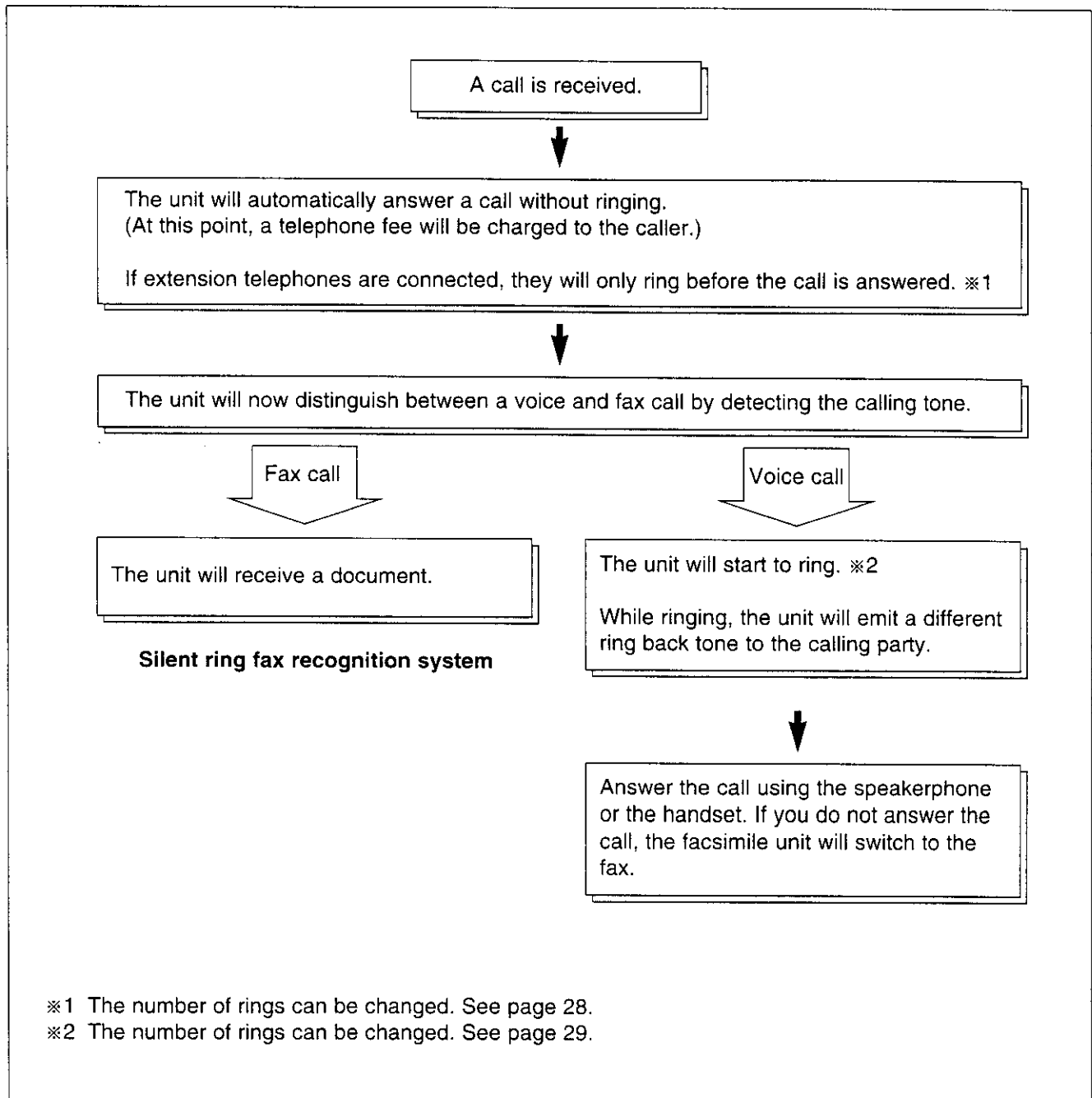

### Note:

- Some fax messages that are transmitted manually may not send a calling tone. These calls must be manually received.
- If your unit is a KX-F2781, you can record the TEL/FAX greeting message (see page 60).
- If your unit is a KX-F2581 and it starts ringing, you cannot answer a call with the extension telephone connected to your unit.

## Setting up the unit

- 1 If your model is KX-F2781, record the TEL/FAX mode greeting message (see page 60).
  - The TEL/FAX mode greeting message will be played to the caller when the unit automatically answers the incoming call.
- 2 Set the MANUAL RECEIVE mode to TEL/FAX (see page 18).
- 3 Make sure that the AUTO RECEIVE mode is turned off.
  - If the FAX or FAX/MSG. SYS indicator light is on, press **AUTO RECEIVE** to turn off the AUTO RECEIVE mode.

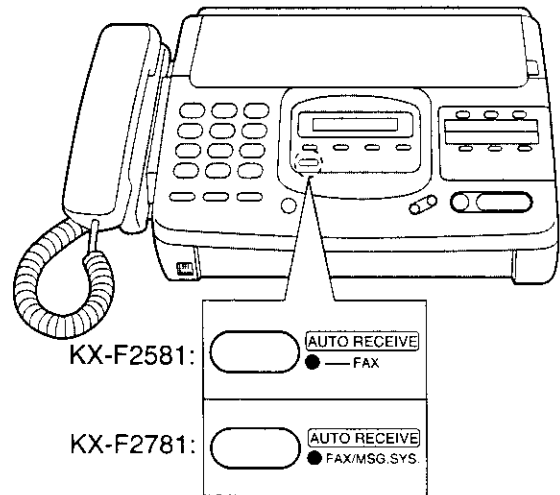

## Setting the TEL/FAX mode ring count

This feature determines the number of rings after which the unit automatically answers a call in the TEL/FAX mode.

You can choose from 2 to 9 rings.

- 1 Press **MENU**.  

SYSTEM SET UP
- 2 Press **#**, then **0** **9**.  

TEL/FAX RING
- 3 Press **START/COPY/SET**.  

RING=2 [▲▼]
- 4 Press **▲** or **▼** to select the desired number.
- 5 Press **START/COPY/SET**.
- 6 Press **MENU**.

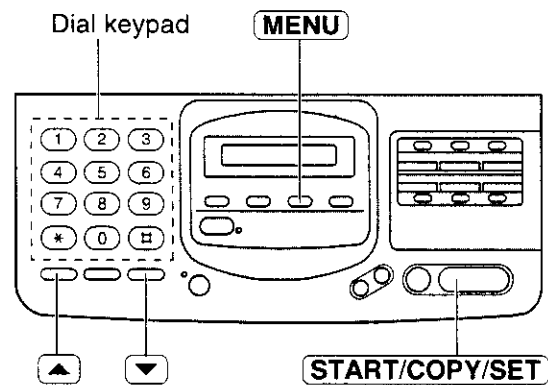

## Setting the silent fax recognition ring count

When a fax call is received in the TEL/FAX mode, the unit will automatically activate the fax function without ringing. If the unit detects a voice call, it will ring. You can choose from 3 to 6 rings.

- 1 Press **MENU**.
- 2 Press **#**, then **3** **0**.
- 3 Press **START/COPY/SET**.
- 4 Press **▲** or **▼** to select the desired number.
- 5 Press **START/COPY/SET**.
- 6 Press **MENU**.

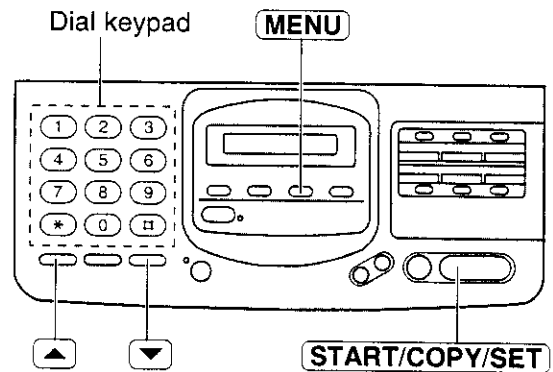

# Making a copy

---

Any transmittable document can be copied (see page 20).

**1** Insert the documents (up to 15 sheets) FACE DOWN until a beep tone is heard.

**2** Press **START/COPY/SET**.

**Note:**

- When copying, the unit will automatically select FINE resolution. To change the resolution, press **RESOLUTION**.
- You can make or receive a voice call while making a copy.

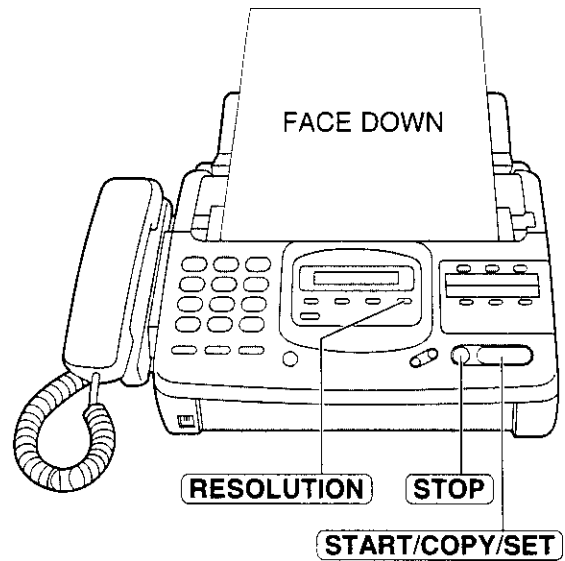

---

## To stop copying

Press **STOP**.

# Operating the answering device (KX-F2781 only) ==

## Listening to messages in common memory \_\_\_\_\_

When the unit receives voice messages;

- the NEW MSGS. indicator will flash,
- the call counter will show the total number of recorded messages, and
- a slow beep will sound if message alert (page 62) is set to ON.

### ■ Listening to new recorded messages

Press **NEW MSGS. PLAY BACK** lightly.

### ■ Listening to all of the recorded messages

Press **NEW MSGS. PLAY BACK** firmly until a beep is heard.

#### Note:

- During playback, the display shows the time and day when each message was recorded and the recorded order of the messages.
- Adjust the speaker volume using **VOLUME**.

#### Voice time/day stamp:

During playback, a synthesized voice will announce the time and day when each message was recorded.

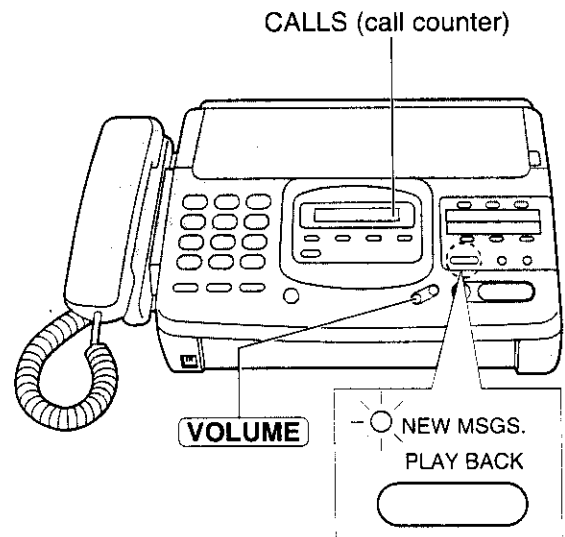

## Erasing recorded messages \_\_\_\_\_

### ■ Erasing specific messages from memory

Press **ERASE** when the message you want to erase is playing.

### ■ Erasing all messages in common memory

1. Press **ERASE** after listening to all of the messages.

ICM ERASE OK?

- To cancel erasing, press **STOP**.

2. Press **START/COPY/SET**.

ERASE COMPLETED

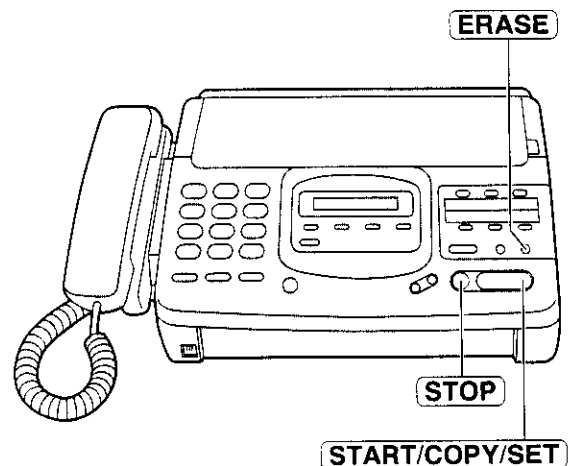

## Functions during playback

### ■ Repeating a message

Press **REPEAT** while the message you want to listen to is playing.

- If you press **REPEAT** within 5 seconds of the beginning of the message, the previous message will be played.
- To play back a specific message, press **REPEAT** repeatedly until the message you want to play back is heard.

### ■ Skipping a message

Press **SKIP** to play back the next message.

### ■ Stopping the operation

Press **STOP** to stop playing back.

- To resume the playback, press **NEW MSGS. PLAY BACK** within 1 minute after pressing **STOP**.

### ■ Changing the playback speed

Press **QUICK** to play back messages at one and a half times the original speed.

Press **SLOW** to play back messages at a half the original speed.

#### To return to the original speed:

Press **QUICK** or **SLOW** again during quick or slow playback.

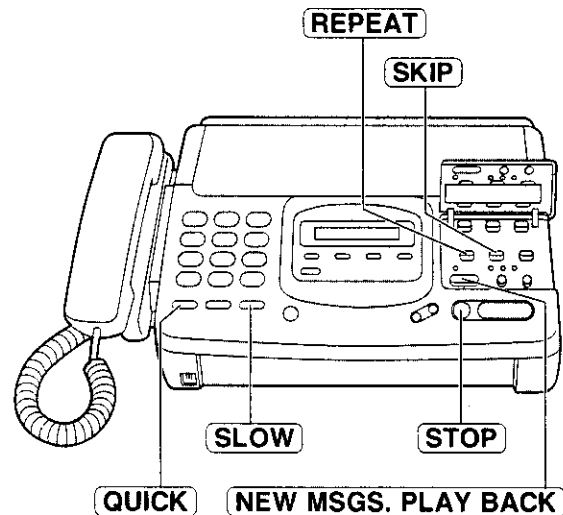



## Recording a memo message

If you are going out and want to leave a private message for someone, you can record a voice memo in the unit. This can be played back later, either directly or remotely, like other messages.

- 1 Open the station key panel.
- 2 Press **MEMO/2WAY REC**.
  - A long beep will sound.
- 3 Speak clearly into the microphone.
- 4 When finished, press **STOP**.

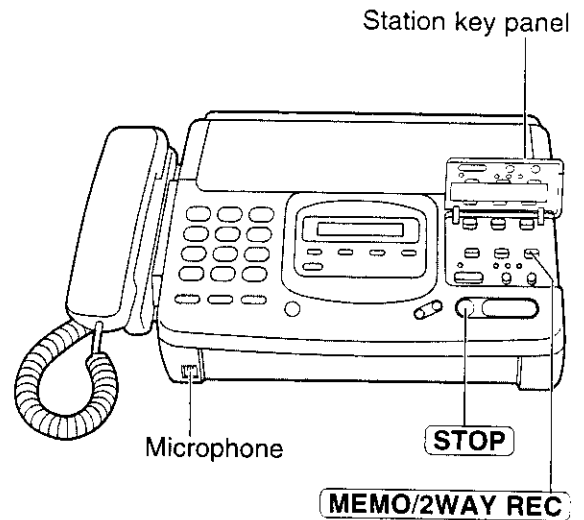

## Recording a telephone conversation

While you are talking with the handset, the telephone conversation can be recorded.

- 1 During a telephone conversation, open the station key panel.
- 2 Press **MEMO/2WAY REC**.  
**2WAY RECORDING**
- 3 To stop recording, press **STOP** or hang up.

### Note:

- All persons using this device for recording telephone conversations shall comply with New Zealand law. This requires that at least one party to the conversation is to be aware that it is being recorded. In addition, the Principles enumerated in the Privacy Act 1993 shall be complied with in respect to the nature of the personal information collected, the purpose for its collection, how it is used and what is disclosed to any other party.

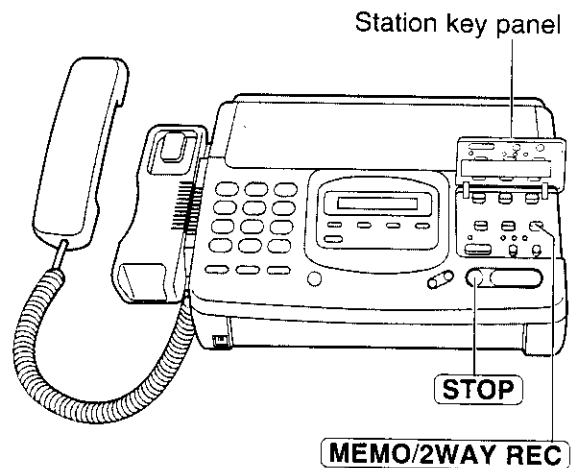

# Storing phone numbers for automatic dialing

The unit's memory allows you to use both one-touch dialing and speed dialing for rapid access to your most frequently dialed numbers.

**One-touch dialing:** The unit is equipped with 5 direct call station keys, each of which is divided into an upper station and a lower station.

**Speed dialing:** The unit is equipped with 50 additional dialing stations. These stations are assigned to 2-digit numbers (00–49).

**1** Press **MENU** until the following message is displayed.

STORE TEL NO.

**2 a: Programming for one-touch dialing:**  
**For upper stations (1–5)**  
 Press one of the direct call station keys.

**For lower stations (6–10)**  
 Press **LOWER**, then press one of the direct call station keys.

**b: Programming for speed dialing:**  
 Press **\***, then press the desired 2-digit number (00–49).

**3** Enter the phone number up to 30 digits in length.  
 •To enter a hyphen in a phone number, press **LOWER**.

**4** Press **START/COPY/SET**.

NAME=

**5** Enter the station name, up to 10 characters, by following the instructions on page 13.

**6** Press **START/COPY/SET**.  
 •To program other stations, repeat steps 2 to 6.

**7** Press **STOP**.

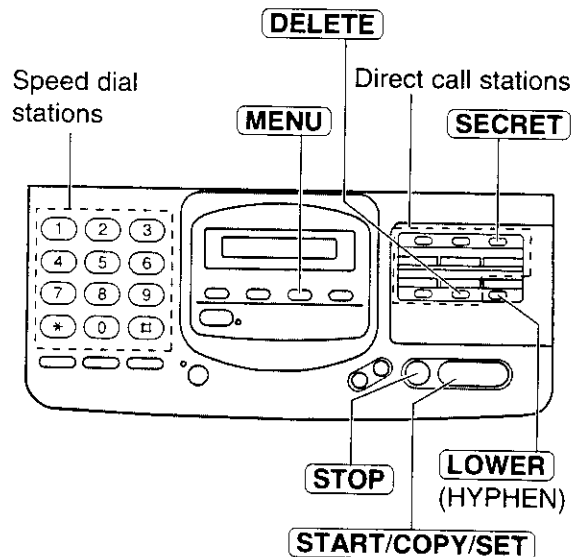

## Helpful hint:

- To confirm stored phone numbers and station names, print a telephone number list (see page 69).

## To keep whole or part of the phone number secret

- Press **SECRET** (direct call station 3) before and after the number you wish to keep secret.
- The phone number will not appear on the display and on the telephone number list.
  - Pressing **SECRET** once counts as two digits.

## To erase a stored number and station name

- Press **STOP** in step 3 to clear the phone number. Press **DELETE** (direct call station 5) repeatedly in step 5 until all of the characters are erased. Then, press **START/COPY/SET**.

# Making voice calls using automatic dialing

- 1 Press **SP-PHONE** or lift the handset.
- 2 **a: Using one-touch dialing:**  
**For upper stations (1–5)**  
Press the desired direct call station key.  
  
**For lower stations (6–10)**  
Press **LOWER**, then press the desired direct call station key.  
  
**b: Using speed dialing:**  
Press **DIRECTORY**, then press **#** and the desired 2-digit number (00–49).

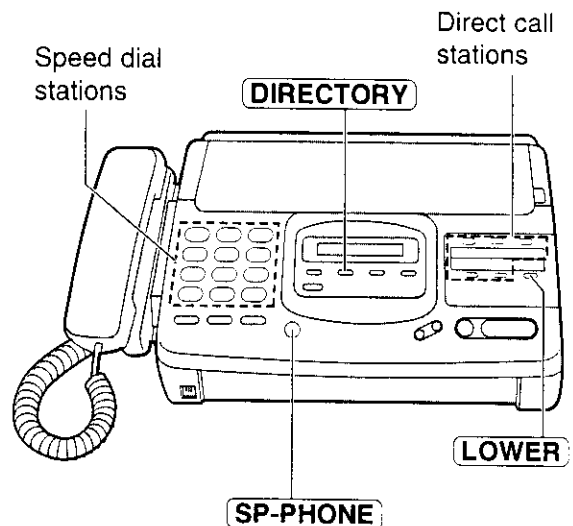

# Transmitting documents using automatic dialing

- 1 Insert the documents FACE DOWN.
- 2 **a: Using one-touch dialing:**  
**For upper stations (1–5)**  
Press the desired direct call station key.  
  
**For lower stations (6–10)**  
Press **LOWER**, then press the desired direct call station key.  
  
**b: Using speed dialing:**  
Press **DIRECTORY**, then press **#** and the desired 2-digit number (00–49).

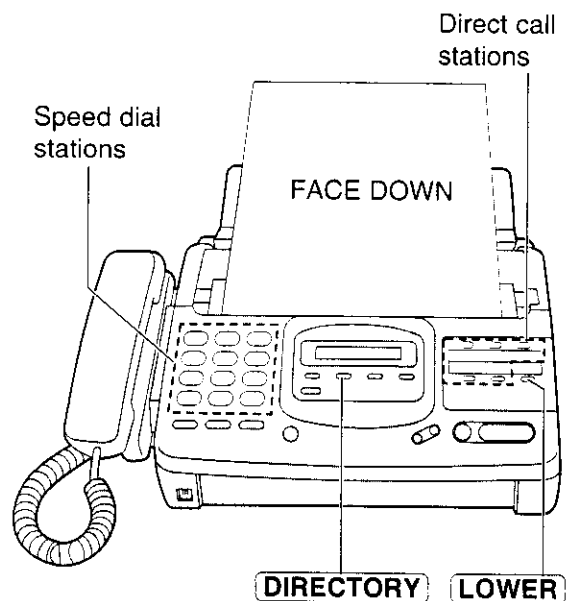

# Electronic telephone directory

The station names stored in memory are automatically registered into the electronic telephone directory in alphabetical order. You can make a fax or voice call by selecting the desired station name on the display.

If you wish to send a fax, insert the documents into the document tray first.

**1** Press **DIRECTORY**.

SELECT INDEX

**2** ■ Press the dial key in which the first initial of the station name is assigned (see index table below).

**Example:** To search a name with the initial "N":  
Press **6** repeatedly until the first station name with initial "N" is displayed. Press **▼** until the desired name is displayed.

OR

■ Press **▲** or **▼** repeatedly until the desired name is displayed.

**3** Press **START/COPY/SET**.

- The unit will start dialing.
- If a document is fed into the unit, the unit will start transmission.

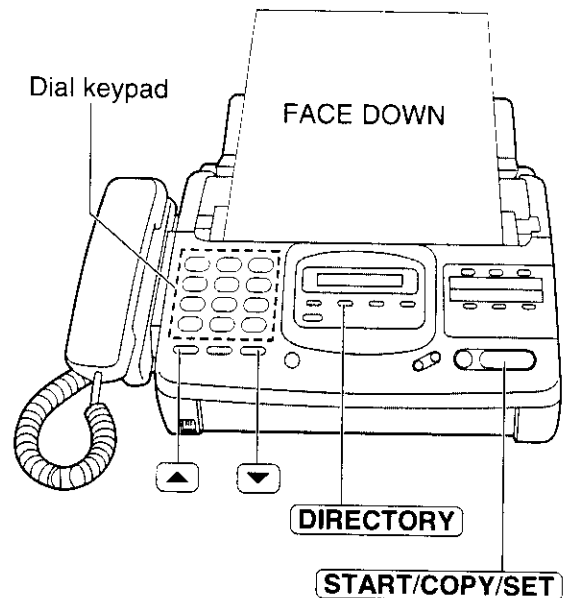

Dial key	Index	Dial key	Index
1	1	7	P, Q, R, S, 7
2	A, B, C, 2	8	T, U, V, 8
3	D, E, F, 3	9	W, X, Y, Z, 9
4	G, H, I, 4	0	0
5	J, K, L, 5	*	Other symbols
6	M, N, O, 6	#	(Used for speed dialing)

# Voice contact

## (talking to the caller during or after fax reception or transmission)

You can have a conversation with the same call after the fax message is completed. This will save the extra expense and time of making another call.

**This feature works only when the other party's unit is equipped with a voice contact feature.**

## Initiating voice contact

- 1 Press **SP-PHONE** while transmitting or receiving documents.

VOICE STANDBY

- Your unit will call the other party with a distinctive ring.

- 2 When the other party answers, the unit will emit a distinctive ring.

Press **SP-PHONE** or lift the handset to start talking.

- If you initiate voice contact during transmission, you can talk after all the documents have been transmitted.
- If you initiate voice contact during reception, you can talk after the current page of the document is received.

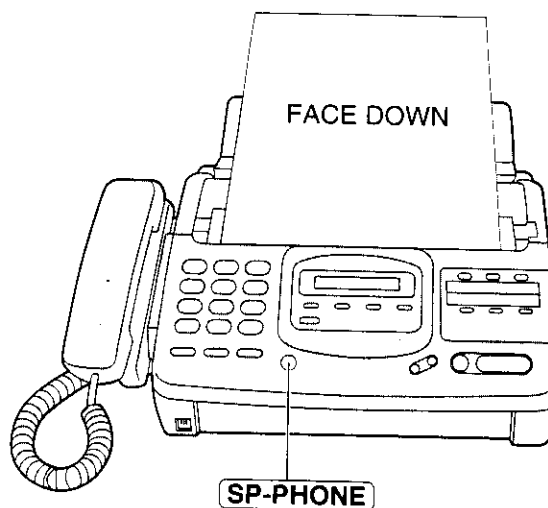

## Receiving a request for voice contact

If the other party initiates voice contact, your unit will emit a distinctive ring after transmission or reception is completed.

When the distinctive ring is heard, press **SP-PHONE** or lift the handset, then start speaking.

### Note:

- If you do not answer within 10 seconds of hearing the distinctive ring, the line will be disconnected. But if your model is KX-F2781 and the ANS/FAX mode is used, the answering system will automatically answer the line and record the incoming voice message.

# TONE, RECALL and REDIAL/PAUSE buttons

## TONE button

The TONE (\*) button is used for rotary pulse dial services and allows you to temporarily change from pulse to tone mode during a dialing operation. When you hang up, the unit will automatically return to pulse mode.

## RECALL button

The RECALL button allows you to use special features of the host exchange (if connected) or local telephone company services such as call waiting. For further details, contact the supplier of your local telephone company.

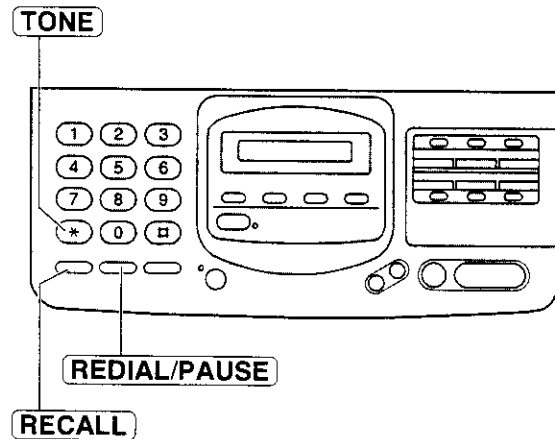

**Note:**

- TONE, RECALL and PAUSE can be stored into a phone number for automatic dialing.

## Entering pauses

If the REDIAL/PAUSE button is pressed during dialing, a pause will be inserted.

**Example-1:** When your unit is connected to a host exchange, insert a pause to get an outside line.

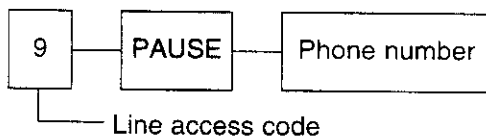

**Example-2:** If transmission errors occur when making an overseas transmission, add two pauses at the end of the phone number.

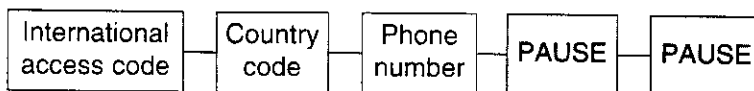

## Redialing the last number dialed

If the REDIAL/PAUSE button is pressed immediately after a dial tone is obtained, the last number dialed will be redialed.

1. Lift the handset or press **SP-PHONE**.
2. Press **REDIAL/PAUSE**.

- If the line is busy when using the speakerphone, the unit will automatically redial the number up to 2 times.

# Polling

## (retrieving fax documents)

The polling feature allows you to receive a document from another compatible machine where you pay for the call as opposed to the document being sent to you, thereby saving the other party call charges.

### Receive polling

To place a call and recover a document from another machine, follow the steps below. Make sure that no documents have been fed into your unit and that the other party's machine is ready for your call.

- 1 Press **MENU** until the following is displayed.

POLLING

- 2 Press **START/COPY/SET**.

NO. =

- 3 Enter the phone number by using one-touch dialing, speed dialing, full number dialing or the electronic telephone directory.

- 4 Press **START/COPY/SET**.

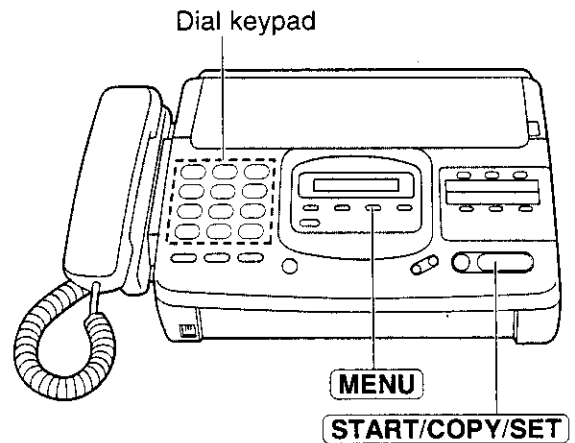

### Transmit polling

A document stored in your unit can be recovered by another party's machine. To let other machines retrieve documents loaded on your unit, proceed as follows.

- 1 Insert the documents FACE DOWN.

- 2 Press **MENU** until the following is displayed.

POLLED

- 3 Press **START/COPY/SET**.

MODE=OFF [▲▼]

- 4 Press ▲ or ▼ to select "ON".

MODE=ON [▲▼]

•If this feature is not required, select "OFF".

- 5 Press **START/COPY/SET**.

POLLED ON

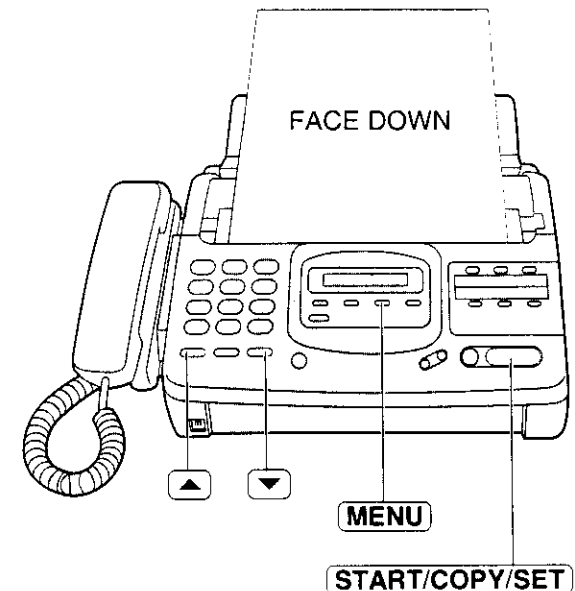

**Note:**

- When delayed transmission (page 40) is set to ON, transmit polling is not available.

# Delayed transmission

## (sending a fax at a later time)

Using a built-in clock, this unit can send documents automatically at a specific time. This allows you to take advantage of low-cost calling hours offered by your telephone company. The delayed transmission can be reserved to take place up to 24 hours.

**1** Insert the documents FACE DOWN.

**2** Press **MENU**.

SYSTEM SET UP

**3** Press **#**, then press **2** **5**.

DELAYED XMT

**4** Press **START/COPY/SET**.

MODE=OFF [▲▼]

**5** Press ▲ or ▼ to select "ON".

MODE=ON [▲▼]

•If this feature is not required, select "OFF".

**6** Press **START/COPY/SET**.

NO. =

**7** Enter the phone number by using one-touch dialing, speed dialing, full number dialing or the electronic telephone directory.

**8** Press **START/COPY/SET**.

TIME=12:00AM

**9** Enter the transmission start time.

**Example:** 11:00PM

Press **1** **1** **0** **0**, then press **#** to select PM.

To select AM, press **\***.

**10** Press **START/COPY/SET**.

**11** Press **MENU**.

•When the programmed time has come, the unit will automatically start transmission.

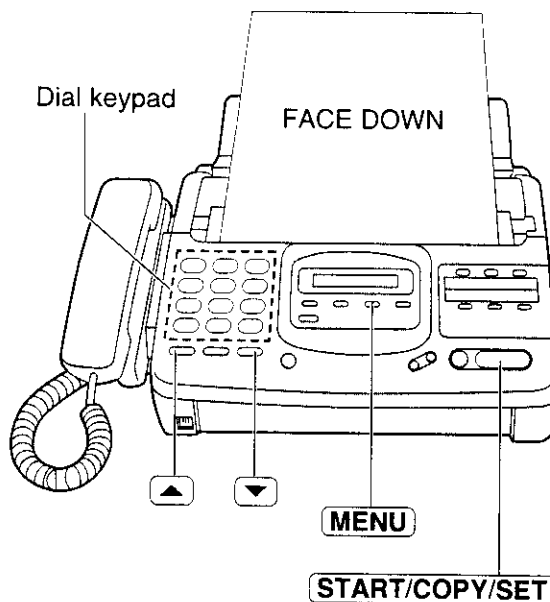

### Note:

- You can receive, transmit and copy documents while delayed transmission is set.
- When transmit polling (see page 39) is ON, delayed transmission is not available.



# Sending documents overseas

You may experience difficulty in transmitting documents overseas. This feature will make sending documents easier as the transmission speed is slowed down. Before starting the transmission procedure, follow the steps below.

1 Press **MENU**.

SYSTEM SET UP

2 Press **#**, then **2** **3**.

OVERSEAS MODE

3 Press **START/COPY/SET**.

MODE=OFF [▲▼]

4 Press ▲ or ▼ to select "ON".

MODE=ON [▲▼]

•If this feature is not required, select "OFF".

5 Press **START/COPY/SET**.

6 Press **MENU**.

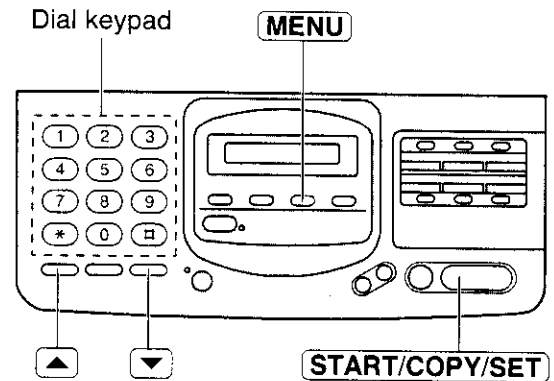

**Note:**

•After transmission, this feature will be turned off automatically.

# Changing the logo print position

The logo, telephone number, date, time and page number will be printed on the transmitted document from your unit in the following manner.

**OUT:** Outside of the transmitted document's paper size (pre-selected setting).

**IN:** Inside of the transmitted document's paper size.

1 Press **MENU**.

SYSTEM SET UP

2 Press **#**, then **2** **1**.

LOGO POSITION

3 Press **START/COPY/SET**.

MODE=OUT [▲▼]

4 Press ▲ or ▼ to select the desired setting.

5 Press **START/COPY/SET**.

6 Press **MENU**.

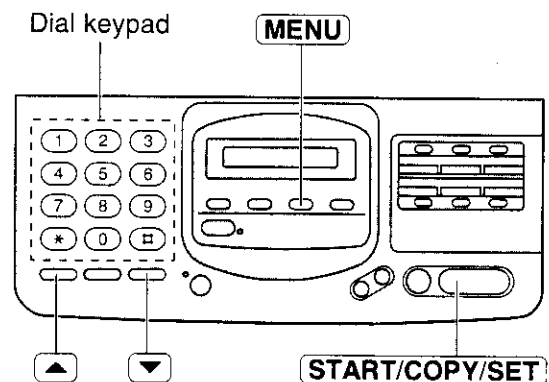

# Remote fax receiving

## (using an extension to receive a fax message)

If you have an extension phone connected to your facsimile unit or on the same line, it is possible to receive a fax message. Using the extension phone, dial the remote fax activation code. This saves you from going to the facsimile unit and pressing **START/COPY/SET**.

### Important:

- To activate this feature, use a touch tone telephone as the extension phone and enter the remote fax activation code **FIRMLY**.
- The remote fax activation code is set to “\*9” as a pre-selected setting.

## Receiving using an extension

- 1 When a call is received, lift the handset of the extension phone.
- 2 When:
  - document reception is required,
  - a slow beep is heard, or
  - no sound is heard,
 enter the remote fax activation code **FIRMLY**.
- 3 Hang up the handset.
  - The facsimile unit is activated for reception.

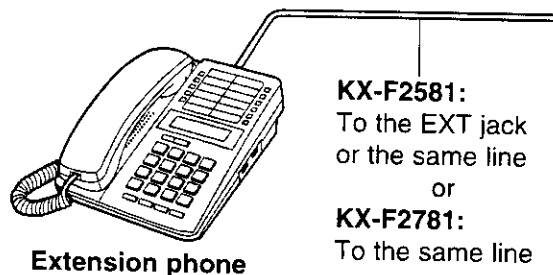

## Changing the remote fax activation code

This code can be from 2 to 4 digits in length using numbers 0 through 9 and the character \*.

- 1 Press **MENU**.  
 SYSTEM SET UP
- 2 Press **#**, then **4** **1**.  
 REMOTE FAX ACT.
- 3 Press **START/COPY/SET**.  
 MODE=ON [▲▼]
- 4 Press **▲** or **▼** to select the desired setting.  
 • If this feature is not required, select “OFF”.
- 5 Press **START/COPY/SET**.  
 CODE=\*9
- 6 Enter the new code number.
- 7 Press **START/COPY/SET**.
- 8 Press **MENU**.

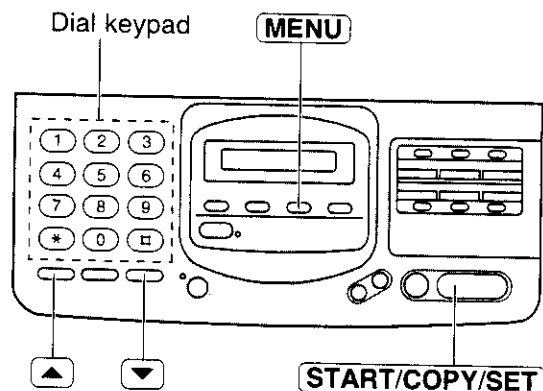

### Note:

- Some special telephone company services will require you to press a service access code. If you subscribe to such services, whole or part of the remote fax activation code must be different from the service access code.
- If the remote fax activation code is set to “0000”, the unit does not work properly.

# Junk mail prohibitor



## (preventing the reception of unwanted fax documents)

This feature prevents reception from facsimile machines whose phone numbers are not stored in automatic dialing.

### Important:

- This feature does not work when:
  - the unit is set to the TEL mode,
  - manual reception is performed, or
  - the other party does not program their facsimile telephone number correctly.
- The junk mail prohibitor ID must be different from the first 2 digits of the remote operation ID (page 56), the mailbox password (page 50) and the remote TAM activation ID (page 48).  
e.g. if the remote operation ID is "321", do not use "32" as a junk mail prohibitor ID.

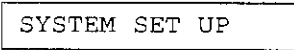
## Setting the junk mail prohibitor and ID

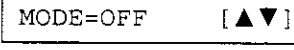
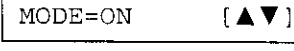
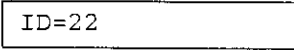
- 1 Press **MENU**.  

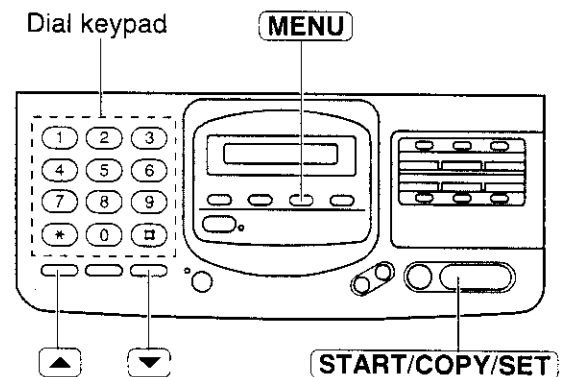
- 2 Press **#**, then **2** **4**.  

- 3 Press **START/COPY/SET**.  

- 4 Press **▲** or **▼** to select "ON".  

  - If this feature is not required, select "OFF".
- 5 Press **START/COPY/SET**.  

- 6 To change the junk mail prohibitor ID, enter the desired 2-digit number.
  - 0, #, and \* cannot be used.
- 7 Press **START/COPY/SET**.
- 8 Press **MENU**.



## Transmitting documents to your unit with the prohibitor ID —

Even if the junk mail prohibitor feature is activated, a designated caller will be able to transmit documents. Give your junk mail prohibitor ID to your designated callers, and advise them of the following steps. This operation is available in the AUTO RECEIVE mode that is set to EXT.TAM (or ANS/FAX), or the MANUAL RECEIVE mode that is set to TEL/FAX.

1. Call your unit from a touch tone telephone.
2. Dial the prohibitor ID while the greeting message is playing or a different ring back tone is heard.
3. Listen for a fax tone, and start transmission.

# Receiving with distinctive ring service (FaxAbility)

**Note for users in New Zealand:** This service is called FaxAbility.

This feature is only for use if you subscribe to a distinctive ring pattern service from their telephone company. For more information on the availability of this service, please contact your telephone company **before** setting this feature on your unit.

The distinctive ring service gives you an additional phone number on a single telephone line, with a different ringing pattern.

When you wish to use the additional phone number as a facsimile telephone number, set the ringing pattern detection feature to ON. When the unit detects a call matching the distinctive ringing pattern, the unit will automatically activate depending on the receive mode setting.

To use this feature properly, set the unit to the TEL/FAX or EXT. TAM (or ANS/FAX) mode.

## Setting the ring pattern detection

**1** Press **MENU**.

SYSTEM SET UP

**2** Press **#**, then **3** **1**.

RING DETECTION

**3** Press **START/COPY/SET**.

MODE=OFF [▲▼]

**4** Press **▲** or **▼** to select "ON".

MODE=ON [▲▼]

• If this feature is not required, select "OFF".

**5** Press **START/COPY/SET**.

**6** Press **MENU**.

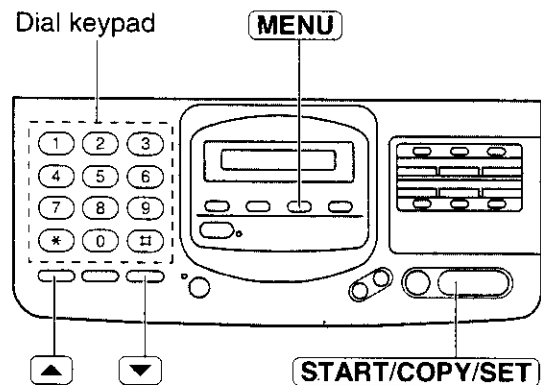

## How the unit will answer in each receive mode

### ■ EXT.TAM or

**ANS/FAX mode:** When a distinctive ringing pattern is detected, the unit will automatically answer the line and activate the fax function to receive documents.

If a standard ringing pattern is received, the fax and/or the answering system will activate depending on the call.

■ **TEL/FAX mode:** When a distinctive ringing pattern is detected, the unit will automatically answer the line and activate the fax function to receive documents.

If a standard ringing pattern is received, the unit will ring until you pick up.

■ **TEL mode:** In this mode, you have to answer all calls manually.

■ **FAX mode:** In this mode, the unit will answer all calls and activate the fax function.

### Note:

• The unit automatically answers a distinctive ring call after the second ring. To change the number of rings, change the FAX mode ring count (page 26) after setting the ring pattern detection.

# Signaling your pager that you have received a fax document

This feature allows your unit to call your pager when your unit receives a fax message.

**1** Press **MENU**.

SYSTEM SET UP

**2** Press **#**, then **7** **0**.

FAX PAGER

**3** Press **START/COPY/SET**.

MODE=OFF [▲▼]

**4** Press **▲** or **▼** to select "ON".

MODE=ON [▲▼]

•If this feature is not required, select "OFF".

**5** Press **START/COPY/SET**.

NO. =

**6** Enter your pager phone number.  
If necessary, press **REDIAL/PAUSE** twice.  
Contact your pager company regarding the proper pause time.

If your pager has the ability to display phone numbers, enter the number that you wish to appear on the display.

Press **#** if required by your pager company.

•You may enter a total of 46 digits and/or pauses.

**7** Press **START/COPY/SET**.

**8** Press **MENU**.

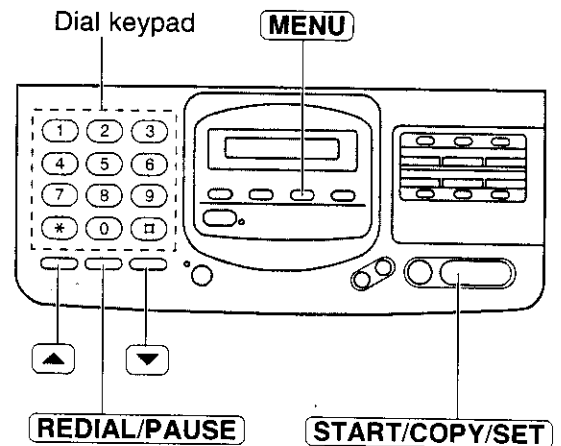

# Using an external telephone answering machine (KX-F2581 only)

This unit can be connected to an external telephone answering machine (TAM). When the EXT.TAM mode is selected, incoming voice messages will be recorded on the telephone answering machine and fax messages will be received by the facsimile unit.

## Note:

- When an external telephone or telephone answering machine is in use, the facsimile unit will show the following message on the display:

EXT. IN USE

When you press the SP-PHONE button on the facsimile unit, the call is switched to the facsimile unit, and the external device will be disconnected.

- If no sound is heard when you lift the handset of the external telephone, the facsimile unit is in use.
- When the facsimile unit rings in the TEL/FAX mode, you cannot answer a call with the external telephone.

## Setting up the answering machine

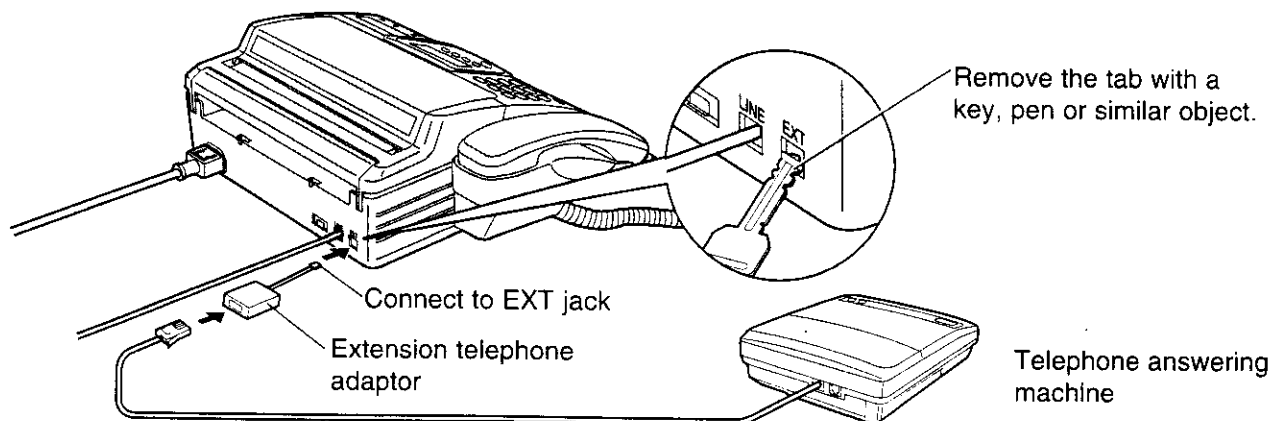

1. Connect the telephone answering machine to the EXT jack.
2. Set the number of rings on the telephone answering machine to less than 4.
3. Record a greeting message referring to the example below.  
*"This is (your name, business and/or telephone number). We are unable to answer the phone right now. Please leave a message after the long beep. To send a fax, dial (my remote fax activation code) and start transmission. Thank you."*

### Notice for recording a greeting message:

- Do not pause for more than 4 seconds in the message.
- Your message can be 8 to 16 seconds long. We recommend you to keep it around 10 seconds in length.
- Inform the fax caller of your remote fax activation code beforehand (see page 42).

## Setting the EXT.TAM mode

To set the facsimile unit and telephone answering machine to allow callers to leave a voice message and send a fax message, proceed as follows.

- 1 Turn on the answering machine.
- 2 Set the AUTO RECEIVE mode to EXT.TAM (see page 18).
- 3 Turn on the AUTO RECEIVE mode by pressing **AUTO RECEIVE** until the FAX indicator light goes on.

- The display shows the following message.

EXT.TAM MODE

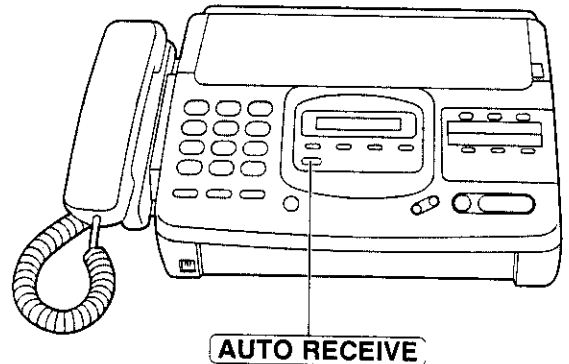

## How to receive incoming calls in the EXT.TAM mode

When a call is received, the facsimile unit and external telephone answering machine will work as follows.

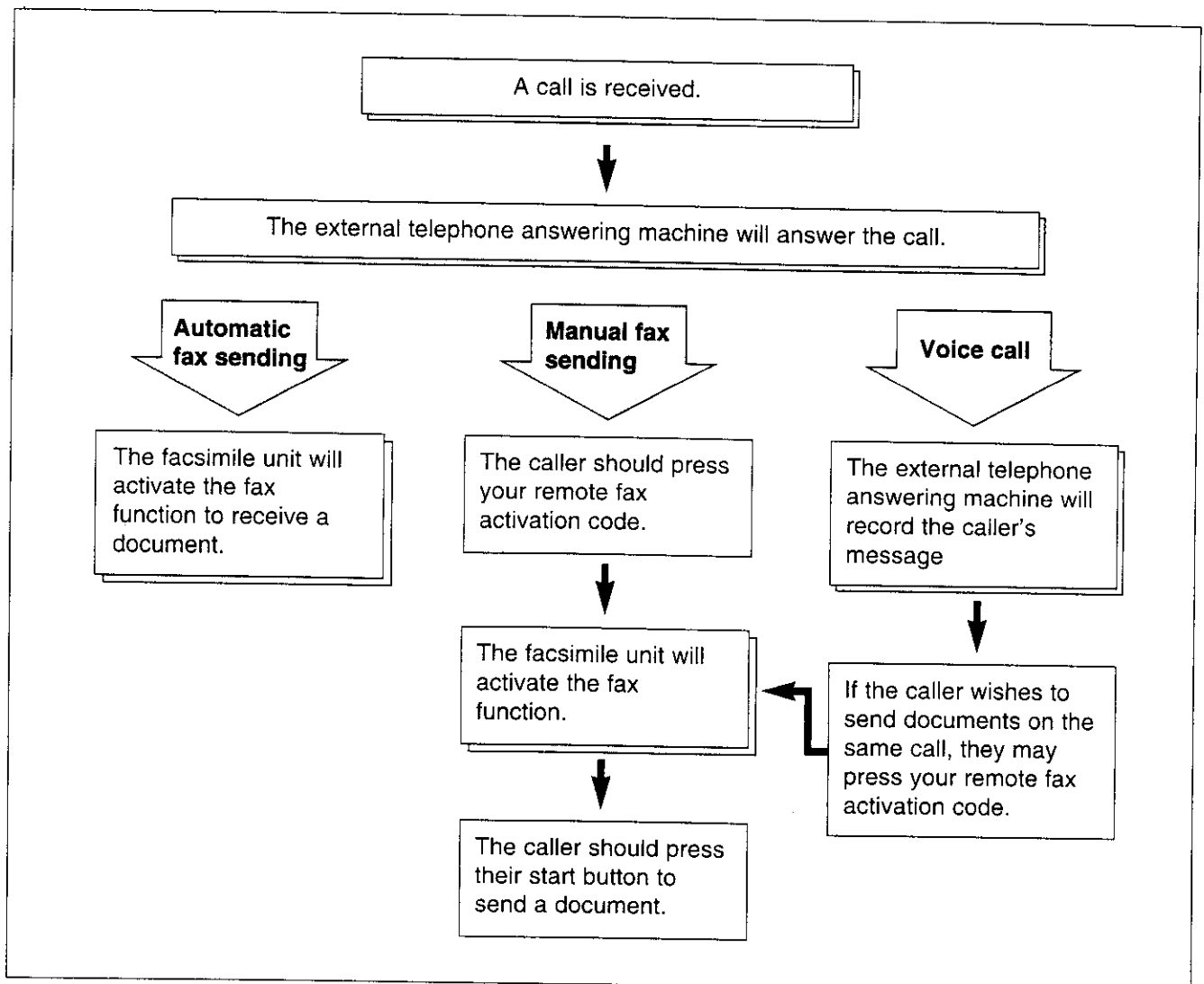

## Setting the remote TAM activation ID

If your answering machine is equipped with a remote operation feature, set the same access code on the facsimile unit as programmed on the answering machine. This feature prevents the facsimile unit from activating the fax function when you operate the answering machine from a remote location. This code can be from 1 to 5 digits in length.

### Important:

- This code should be different from the remote fax activation code (see page 42) and the junk mail prohibitor ID (see page 43).

1 Press **MENU**.

SYSTEM SET UP

2 Press **#**, then **1** **2**.

REMOTE TAM ACT.

3 Press **START/COPY/SET**.

MODE=OFF [▲▼]

4 Press **▲** or **▼** to select "ON".

MODE=ON [▲▼]

5 Press **START/COPY/SET**.

ID=11

- The display will show the pre-selected ID.

6 Enter the new ID number using the dial keypad.

7 Press **START/COPY/SET**.

8 Press **MENU**.

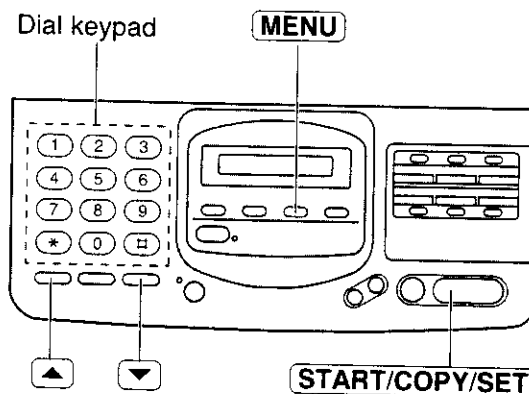



## Setting the silent detection

This feature allows the facsimile unit to activate the fax function automatically when a silent pause longer than 4 seconds is detected in the EXT.TAM mode.

### Helpful hints:

- If you wish to receive documents from stations that do not send a calling tone after dialing, activate this feature.
- If you use a single cassette tape to give a greeting message and to record incoming messages, deactivate this feature.

1 Press **MENU**.

SYSTEM SET UP

2 Press **#**, then **4 0**.

SILENT DETECT.

3 Press **START/COPY/SET**.

MODE=ON [▲▼]

4 Press **▲** or **▼** to select the desired mode.

5 Press **START/COPY/SET**.

6 Press **MENU**.

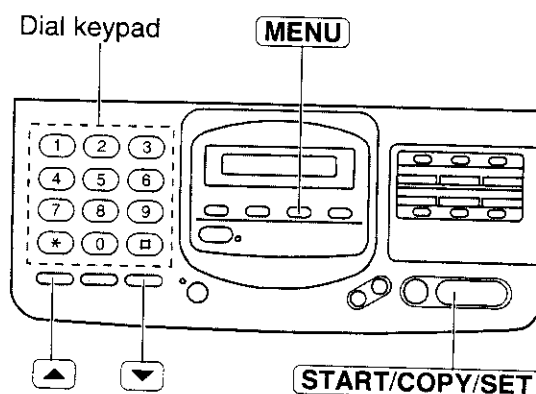

## Notice when using with an answering machine

- Every time the facsimile unit receives a document, a silent pause or a fax tone may be recorded on the answering machine.
- Advise callers that they should not pause for over 4 seconds while recording their voice messages. Otherwise, the unit may switch to the fax mode.
- When your answering machine runs out of recording tape, the facsimile unit may not be able to receive a document. Rewind the tape to record messages.
- When you set the answering machine to give only a greeting message, fax reception may not be available.
- If you answer a call with the answering machine and pause for over 4 seconds, the facsimile unit may switch to the fax mode and you may not be able to talk with the other party.
- When the answering machine does not answer a call after 5 rings, the fax function will be activated.
- Set the receive mode of the facsimile unit to the TEL mode under the following conditions:
  - when you wish to set the number of rings on the answering machine to more than 5, or
  - when you wish to use the auto transfer functions (transfer, pager alert, etc.) on the answering machine.Note that automatic fax sending can not be received automatically in the TEL mode.

# Voice mailbox (KX-F2781 only)

## (how callers can leave you private messages)

This unit has three mailbox memories. Your caller can leave a message in a specific mailbox. Only the person who knows the password can retrieve a message from a mailbox.

This feature is useful when you use this unit with other people and when a caller would like to leave a message directly to a specific person.

### To use a mailbox:

1. Program the mailbox password (see below).
2. Inform the mailbox number to callers.
3. Set the unit to the ANS/FAX mode (see page 18).

### Pre-recorded greeting messages:

The unit has a pre-recorded greeting message in each memory. When you do not record your own greeting message, the pre-recorded greeting message will be played.

#### Pre-recorded greeting message (e.g. Mailbox 1):

*This is mailbox 1.  
Please leave your name and message after the beep.*

- To record your own greeting message, see page 60.

## Programming the mailbox password

Program your own password for your mailbox to prevent other users from retrieving messages. Choose any 3-digit number except a number using digits 0 or 7.  
The mailbox password must be different from the first 2 digits of the junk mail prohibitor ID (page 43) and the remote operation ID (page 56).

- 1 Press **MENU**.

SYSTEM SET UP

- 2 For mailbox 1, press **#**, then **5** **1**.

BOX1 PASSWORD

- For mailbox 2, press **#**, then **5** **2**.

BOX2 PASSWORD

- For mailbox 3, press **#**, then **5** **3**.

BOX3 PASSWORD

- 3 Press **START/COPY/SET**.

NO. =

- 4 Enter the new password.

- 5 Press **START/COPY/SET**.

- To program other passwords, repeat from step 2.

- 6 Press **MENU**.

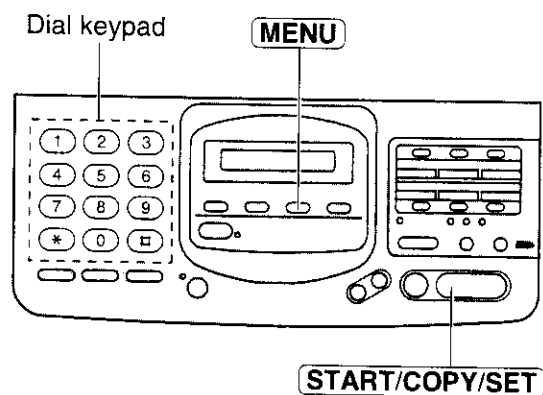

## How incoming messages are recorded in a mailbox

- 1 Call your unit from a touch tone telephone.
  - The ANS/FAX greeting message will be played.
- 2 Press **[\*]** and the desired mailbox number (**[1]**, **[2]** or **[3]**).
  - A mailbox greeting message will be played.
- 3 After the beep, leave a message.

### Pre-recorded greeting message:

*Hello! We are unable to answer right now.  
To send a fax, please start transmission.  
To leave a voice message, please speak after the beep.  
Thank you.*

*This is mailbox (1-3).  
Please leave your name and message after the beep.*

## Recording a memo message and a telephone conversation

You can record a memo message and a telephone conversation into a mailbox. Press **MAIL BOX** until the desired mailbox number is displayed and follow the instructions on page 33.

- If you record a telephone conversation, set the desired mailbox number after lifting the handset.

## Listening to messages in a mailbox

When there is a new message in a mailbox,  
—the mailbox number indicator will flash, and  
—a slow beep will sound if mailbox alert is set to ON (see page 52).

- 1 Press **MAIL BOX** until the desired mailbox number is displayed.
 

**Example:** Mailbox 2

BOX2	02
------	----
- 2
  - If you leave the mailbox password as "555" (pre-selected setting):  
Press **NEW MSGS. PLAYBACK** lightly.
  - OR
  - If you program your own password:  
Press **NEW MSGS. PLAYBACK** lightly, then enter your password.

PASSWORD=
-----------

  - The unit will play back the new recorded messages.
- 3 To exit the mailbox, press **STOP**.

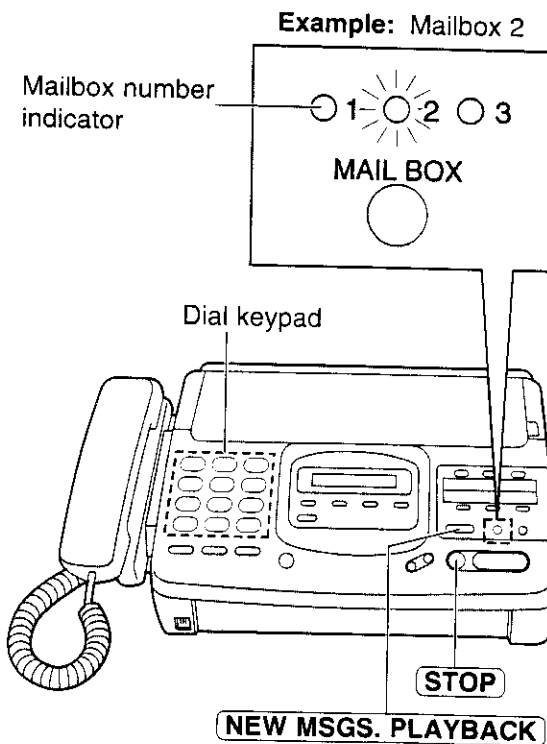

### Note:

- **REPEAT**, **SKIP**, **STOP**, **QUICK** and **SLOW** can be used during playback (see page 32).
- To listen to all of the recorded messages, press **NEW MSGS. PLAYBACK** firmly in step 2 until a beep is heard.

## Erasing recorded messages in a mailbox

### Erasing a specific message in a mailbox

Press **ERASE** while the message you want to erase is playing.

### Erasing all messages in a mailbox

**1** Press **MAIL BOX** until the desired mailbox number is displayed.

Example: Mailbox 1

BOX1 02

**2** Press **ERASE**.

BOX1 ERASE OK?

**3** Press **START/COPY/SET**.

ERASE COMPLETED

**4** To exit the mailbox, press **STOP**.

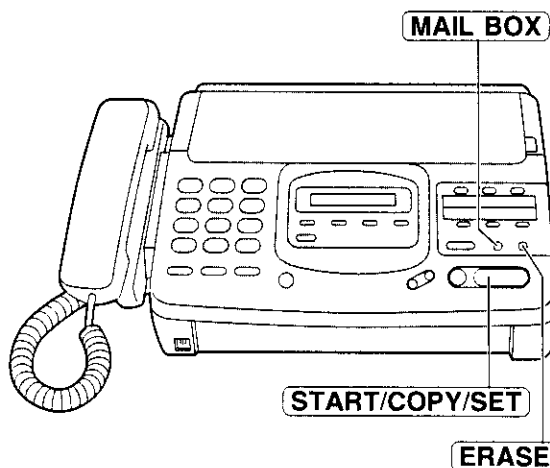

## Setting the mailbox alert

This feature allows your unit to alert you with a slow beep that a caller's message is recorded in a mailbox.

**1** Press **MENU**.

SYSTEM SET UP

**2** Press **#**, then **5** **0**.

MAIL BOX ALERT

**3** Press **START/COPY/SET**.

MODE=OFF [▲▼]

**4** Press **▲** or **▼** to select "ON".

MODE=ON [▲▼]

•If this feature is not required, select "OFF".

**5** Press **START/COPY/SET**.

**6** Press **MENU**.

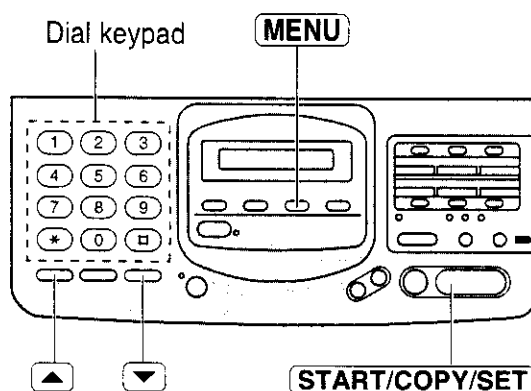

# Transferring incoming calls (KX-F2781 only)

This feature allows your unit to call the desired telephone number or pager phone number, each time an incoming voice message is recorded in common or mailbox memories. You can choose either **Message Transfer** or **Pager Call** per each memory.

**Message transfer:** Program the transfer phone number first. When an incoming message is recorded in your unit, the message will be transferred. You can retrieve the message on the same call by the remote operation.  
**Pager call:** Program the pager phone number first. When an incoming call is recorded, your pager will be called. Call your unit and retrieve the message by the remote operation.

- This feature is available in the ANS/FAX mode.
- For details on the remote operation, see page 55.
- Use a touch tone telephone to access your unit.

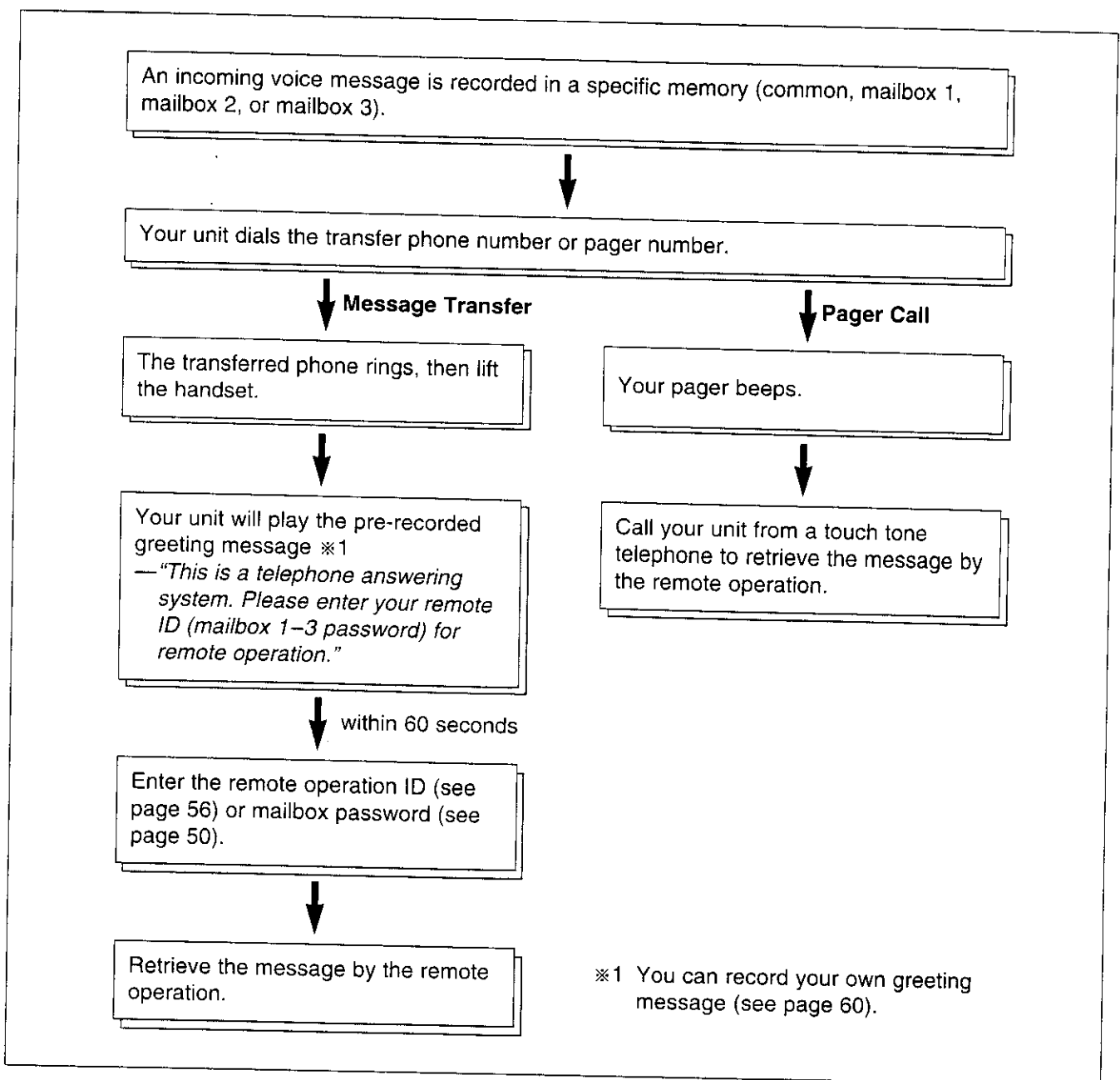

# Setting the message transfer/pager call

**1** Press **MENU**.  

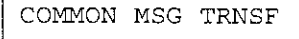
**2** For common message transfer, press **#**, then **6 0**.  

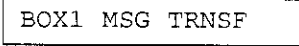
For mailbox 1 message transfer, press **#**, then **6 1**.  

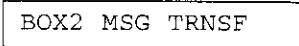
For mailbox 2 message transfer, press **#**, then **6 2**.  

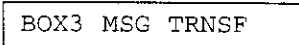
For mailbox 3 message transfer, press **#**, then **6 3**.  

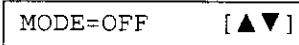
**3** Press **START/COPY/SET**.  

**4** Press **▲** or **▼** to select the desired setting.  
**MESSAGE:** transfers incoming messages.  
**PAGER:** calls your pager.  
**OFF:** turns off this feature.

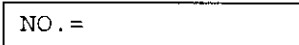
**5** Press **START/COPY/SET**.  

**6 a:** If you selected "MESSAGE" in step 4:  
 Enter the number where the message is to be transferred.

**b:** If you selected "PAGER" in step 4:  
 Enter your pager phone number.

If necessary, press **REDIAL/PAUSE** twice.  
 Contact your pager company regarding the proper pause time.  
 If your pager has the ability to display phone numbers, enter the number that you wish to appear on the display.  
 Press **#** if required by your pager company.

- You may enter a total of 46 digits and/or pauses.

**7** Press **START/COPY/SET**.

**8** Press **MENU**.

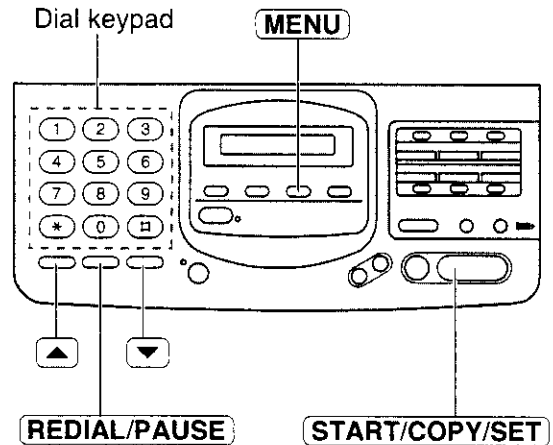

**Note:**  
 • This feature can be turned on/off remotely from a touch tone phone (see page 59).

# Operating the answering device from a remote phone (KX-F2781 only)

The following operations are available from a remote location with a touch tone telephone. Set the unit to the ANS/FAX mode in the AUTO RECEIVE mode before going out (see page 18).

Dial key	Remote command	Page	Dial key	Remote command	Page
[1]	Repeats a message	58	*[5]	Erases all messages	58
[2]	Skips a message	58	[8][1]	Turns on message transfer /pager call for incoming messages	59
[4]	New message playback	57			
[5]	All message playback	57	[8][2]	Turns off message transfer /pager call for incoming messages	59
[7]	Re-records a greeting message	59			
[9]	Stops re-recording of a greeting message	59	[0]	Skips the greeting message	59
*[4]	Erases a specific message	58			

## Remote operation card

You may cut out this remote operation card to use.

Mailbox Remote Operation	Notice of Remote Operation
<p>■ <b>Recording a message in a mailbox:</b></p> <ol style="list-style-type: none"> <li>1. Call your unit.</li> <li>2. Press [*] and the mailbox no. ([1], [2] or [3]).</li> <li>3. Leave a message.</li> </ol> <p>■ <b>Retrieving messages from a mailbox:</b></p> <ol style="list-style-type: none"> <li>1. Call your unit.</li> <li>2. Press [*] and the mailbox no. ([1], [2] or [3]).</li> <li>3. Enter the mailbox password [ ][ ].</li> <li>4. Press the remote command key (refer to the reverse side).</li> </ol>	<ul style="list-style-type: none"> <li>• The remote operation is available only from a touch tone phone when the unit is in the ANS/FAX mode.</li> <li>• When the unit is in the TEL mode, call your unit and wait for 15 rings. The answering system will temporarily answer the line. Enter the remote operation ID during the greeting message. The unit will switch to the ANS/FAX mode.</li> <li>• When you press any key, press firmly.</li> <li>• To send a document, press [*][*]. When a fax tone is heard, start transmission.</li> </ul>

Fold here

# Programming the remote operation ID

The remote operation ID is used to access the answering device common memory. Choose any 3-digit number except a number using digits 0 or 7.

Make sure that the first 2-digits of the remote operation ID are different from the junk mail prohibitor ID (page 43) and the mailbox password (page 50).

**1** Press **MENU**.

SYSTEM SET UP

**2** Press **#**, then **1 1**.

REMOTE ANS ID

**3** Press **START/COPY/SET**.

ID=111

**4** Enter the desired number.

**5** Press **START/COPY/SET**.

**6** Press **MENU**.

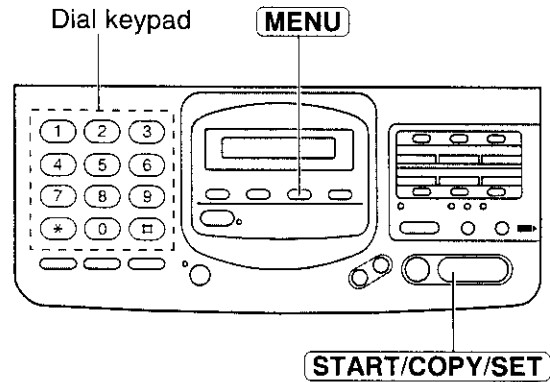

## Answering Device Remote Operation

1. Call your unit.
2. Enter the remote operation ID    during the greeting message.
3. Press the remote command key (refer to the right) within 4 seconds.  
or  
Wait for 4 seconds. All the recorded messages will be played back.

Key	Remote Command
<input type="button" value="0"/>	Skips the greeting message
<input type="button" value="1"/>	Repeats a message
<input type="button" value="2"/>	Skips a message
<input type="button" value="4"/>	New message playback
<input type="button" value="5"/>	All message playback
<input type="button" value="7"/>	Re-records a greeting message
<input type="button" value="9"/>	Stops re-recording of a greeting message
<input type="button" value="*4"/>	Erases a specific message
<input type="button" value="*5"/>	Erases all messages
<input type="button" value="81"/>	Message transfer/Pager call ON
<input type="button" value="82"/>	Message transfer/Pager call OFF



## Listening to messages in common memory

- 1 Call your unit.
- 2 Enter the remote operation ID during the ANS/FAX greeting playback.

—The voice guide will tell you the number of new recorded messages.

### Example of the voice guide:

*3 new messages in common memory.  
No new messages in mailbox.*

- 3 Press **[4]** to listen to the new recorded messages.  
OR  
Press **[5]** or wait for 4 seconds to listen to all of the recorded messages.

—The voice guide will tell you how to operate the unit during playback.

*Playback 3 new messages.  
Press **[1]** to repeat message.  
Press **[2]** to skip message.  
Press **[\*]** **[4]** to erase a specific message.*

## Listening to messages in a mailbox

- 1 Call your unit.
- 2 Press **[\*]** and the desired mailbox number (**[1]**, **[2]** or **[3]**) during the ANS/FAX greeting playback.

### Example of mailbox greeting message:

*This is mailbox (1-3).  
Please leave your name and message  
after the beep.*

- 3 Enter the mailbox password during the mailbox greeting message.

—The voice guide will tell you the number of new recorded messages.

### Example of the voice guide:

*3 new messages in mailbox (1-3).*

- 4 Press **[4]** to listen to the new recorded messages.  
OR  
Press **[5]** or wait for 4 seconds to listen to all of the recorded messages.

—The voice guide will tell you how to operate the unit during playback.

*Playback 3 new messages.  
Press **[1]** to repeat message.  
Press **[2]** to skip message.  
Press **[\*]** **[4]** to erase a specific message.*

## To listen to messages in another memory after playback

1. Press **[\*]** and **[0]** (for common memory), then enter the remote operation ID.  
or  
Press **[\*]** and the desired mailbox number (**[1]**, **[2]** or **[3]**), then enter the mailbox password during the mailbox greeting message.
2. Press **[4]** or **[5]** to play back messages.

## During playback

### ■ Repeating a message

Press **[1]** to play the current message.

—If you press **[1]** within 5 seconds of playback, the previous message will be played.

### ■ Skipping a message

Press **[2]** to play back the next message.

#### Note:

- If you hear the voice guide after playing back the messages, memory is full. Erase some or all of the messages.

#### Example of the voice guide:

*Not enough recording time. Please erase unnecessary messages.*

## Erasing incoming messages from memory

### ■ Erasing a specific message from memory

Press **[\*] [4]** when the message you want to erase is played.

—A long beep and the voice guide will be heard.  
Then the unit will continue with the next message.

#### Example of the voice guide:

*The message has been erased.*

### ■ Erasing all messages from a specific memory

You can erase all of the recorded messages from common and each mailbox memory.  
To erase all of the messages in a mailbox, you must first select a mailbox.

Press **[\*] [5]** when you want to erase the messages in a specific memory.

—A long beep and the voice guide will be heard.

#### Example of the voice guide:

*All messages have been erased.*

## Other remote operations

### ■ Recording a marker message

After playing back the recorded messages, you can leave an additional message.

1. Wait for the voice guide indicating the end of the remote operation.
2. Wait about 10 seconds.
3. Hear the voice guide.
4. Leave a message.

#### Example of the voice guide:

*All messages have been played.*

*Please leave your name and message after the beep.*

## ■ Re-recording a greeting message

You can change the contents of the greeting messages for the ANS/FAX mode and mailbox memories. To re-record a mailbox greeting message, you must first select a mailbox.

1. Press **[7]** to start recording during the remote operation.
  - A long beep will sound.
2. Speak up to 16 seconds.
  - If you pause for over 2 seconds, 6 beeps will sound and the recording will stop. Repeat from step 1 within 10 seconds.
3. When finished, press **[9]**.
  - The new greeting message will be played.

## ■ Turning message transfer/pager call on or off

You can remotely turn on or off message transfer/pager call for incoming messages. You must program a transfer phone number or a pager number in advance (see page 54).

Press **[8] [1]** to turn ON message transfer/pager call during the remote operation.

### Example of the voice guide:

*Message transfer is set.  
Transfer phone number is 123456789.  
or  
Pager call is set.  
Pager number is 098765432.*

Press **[8] [2]** to turn OFF message transfer/pager call.

*Message transfer is off.  
or  
Pager call is off.*

—If a transfer phone number or a pager number is not programmed, the voice guide will be played. You cannot turn this feature on.

*Transfer phone number is not set.  
or  
Pager number is not set.*

## ■ Skipping the greeting message

You can skip the greeting message.

Press **[0]** during the greeting message playback.  
—The unit will skip the rest of the greeting message.

# Recording your own greeting messages

(KX-F2781 only)

You can record your own greeting messages. The recording time is limited to 16 seconds for each message. Record a greeting message within 12 seconds for optimum performance.

- As for the ANS/FAX greeting message, you can choose 16 seconds or 60 seconds of recording time (see page 63).

## Suggested messages

ANS/FAX greeting message	"This is (your name, business and/or telephone number). We are unable to answer right now. To send a fax, start transmission. To leave a message, speak after a long beep. Thank you."
TEL/FAX greeting message	"This is (your name, business and/or telephone number). Please wait for someone to answer your call. To send a fax, start transmission."
Mailbox 1 greeting message Mailbox 2 greeting message Mailbox 3 greeting message	"This is (personal name). Please leave your name and message after the beep."
Message transfer greeting	"This is a transferred message from (your name, business and/or telephone number). Please enter your remote ID (mailbox 1-3 password) for remote operation."

### Note:

- If you do not record your own greeting messages, the pre-recorded greeting messages will be played.

## Recording a greeting message

- 1 Open the station key panel.
- 2 Press **SELECT** until the following is displayed.
  - For the ANS/FAX greeting:
 

ANS-GREETING
  - For the TEL/FAX greeting:
 

TEL-GREETING
  - For mailbox 1-3 greeting:
 

Example: Mailbox 2

BOX2-GREETING
  - For message transfer greeting:
 

TRNS-GREETING
- 3 Press **REC**.
  - A long beep will sound.
- 4 Speak clearly 20 cm (8 inches) away from the microphone.
  - The display will show the elapsed recording time.
  - Example: ANS/FAX greeting

ANS REC. 02s
- 5 When finished, press **STOP**.
  - The unit will repeat your message. Adjust the volume using **VOLUME**.

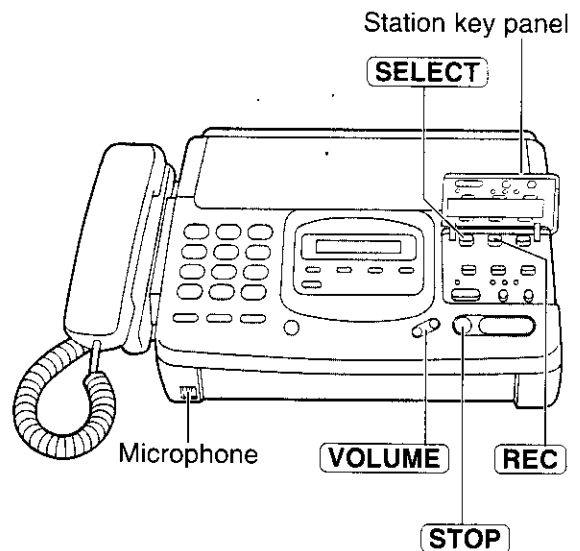

### Note:

- If you make a mistake while recording, repeat from step 2.

## Checking greeting messages

- 1 Open the station key panel.
- 2 Press **SELECT** until the desired greeting is displayed.

**Example:** Mailbox 3 greeting

BOX3-GREETING

- 3 Press **CHECK**.
  - After the beep, the unit will play back the message.
  - Adjust the volume using **VOLUME**.

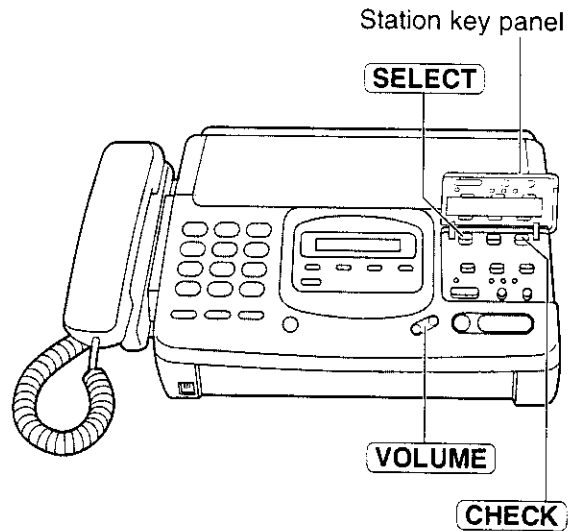

## Erasing your own recorded greeting messages

- 1 Open the station key panel.
- 2 Press **SELECT** until the desired greeting is displayed.

**Example:** Mailbox 2 greeting

BOX2-GREETING

- 3 Press **ERASE**.

ERASE OK?

- 4 Press **START/COPY/SET**.

GREETING ERASED

- 5 Press **STOP**.

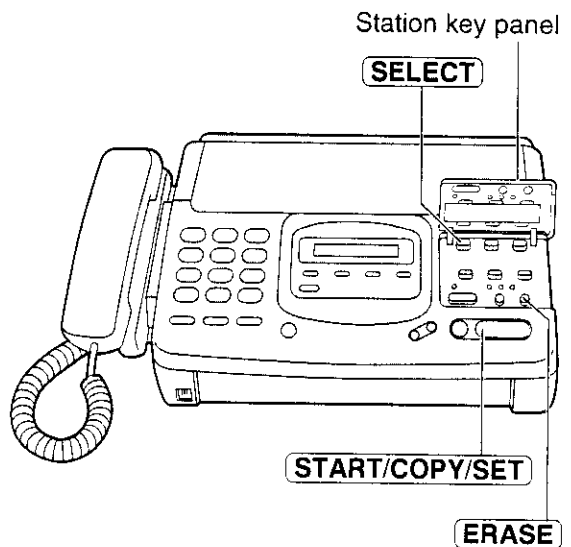

### Note:

- If you erase your own recorded greeting messages, the pre-recorded greeting messages will be played.

# Changing the caller's recording time

## (KX-F2781 only)

You can choose from two lengths of recording times for incoming messages.

**VOX (unlimited):** The unit records an incoming message as long as the caller speaks (pre-selected setting).

**1 MIN (1 minute):** The unit will record each incoming message up to 1 minute.

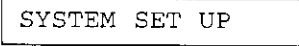
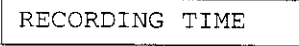
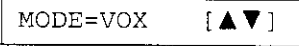
- 1 Press **MENU**.  

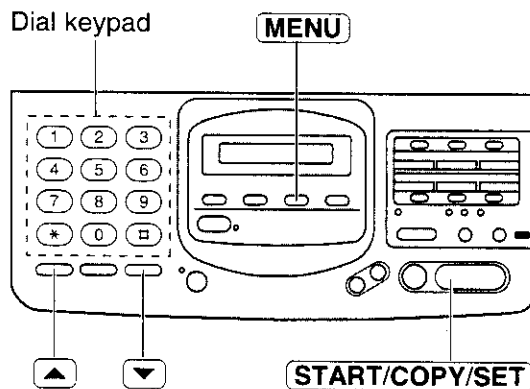
- 2 Press **#**, then **1** **0**.  

- 3 Press **START/COPY/SET**.  

- 4 Press **▲** or **▼** to select the desired setting.
- 5 Press **START/COPY/SET**.
- 6 Press **MENU**.

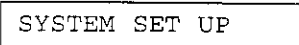
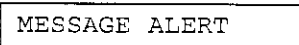
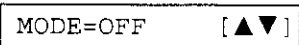
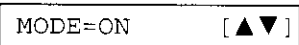

# Setting the message alert (KX-F2781 only)

When this feature is on, the unit will let you know with a slow beep that a caller's message is recorded in the common memory.

- 1 Press **MENU**.  

- 2 Press **#**, then **4** **2**.  

- 3 Press **START/COPY/SET**.  

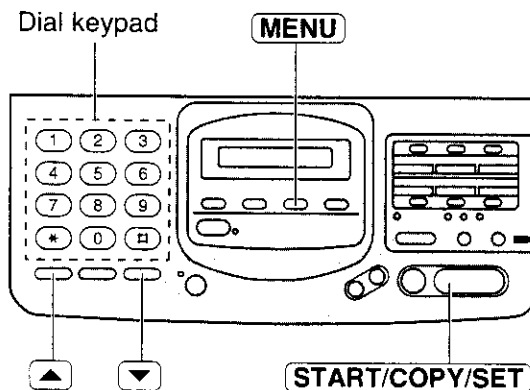
- 4 Press **▲** or **▼** to select "ON".  

•If this feature is not required, select "OFF".

- 5 Press **START/COPY/SET**.
- 6 Press **MENU**.



# Setting the recording time alert (KX-F2781 only) ---

With this feature, when the remaining time to record incoming messages becomes less than 60 seconds, the unit will alert the user with a slow beep.

- 1 Press **MENU**.  
SYSTEM SET UP
- 2 Press **#**, then **4** **3**.  
REC. TIME ALERT
- 3 Press **START/COPY/SET**.  
MODE=OFF [▲▼]
- 4 Press **▲** or **▼** to select "ON".  
MODE=ON [▲▼]

• If this feature is not required, select "OFF".

- 5 Press **START/COPY/SET**.
- 6 Press **MENU**.

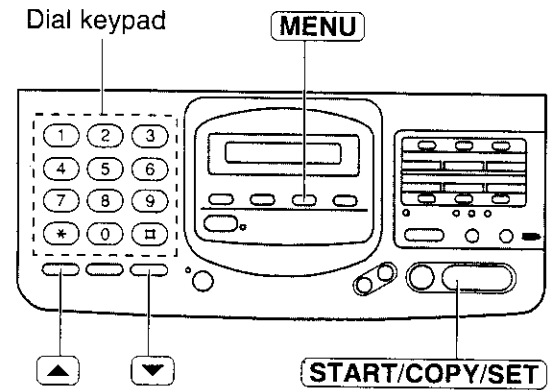

# Changing the recording time for the ANS/FAX greeting message (KX-F2781 only) ---

You can choose 16 seconds or 60 seconds of recording time.

- 1 Press **MENU**.  
SYSTEM SET UP
- 2 Press **#**, then **5** **4**.  
GREETING TIME
- 3 Press **START/COPY/SET**.  
MODE=16s [▲▼]
- 4 Press **▲** or **▼** to select the desired setting.
- 5 Press **START/COPY/SET**.
- 6 Press **MENU**.

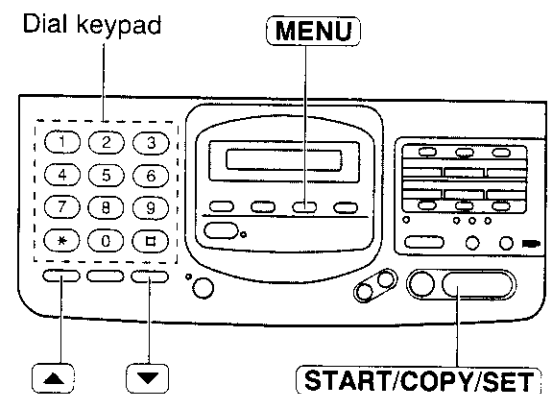

## Note:

- If you change the greeting message time to 60 seconds, we recommend that you inform the caller in the ANS/FAX greeting message to press \*\* before starting fax transmission.
- If you change the greeting message time to 16 seconds from 60 seconds, your ANS/FAX greeting message is deleted. Re-record a greeting message (see page 60).

# Setting the friendly reception

The friendly reception feature allows you to receive fax documents automatically without pressing **START/COPY/SET**. See page 23 for further details.

If you set this feature to OFF, you will have to press **START/COPY/SET** to receive fax documents each time you answer a call.

1 Press **MENU**.

SYSTEM SET UP

2 Press **#**, then **4** **6**.

FRIENDLY RCV

3 Press **START/COPY/SET**.

MODE=ON [▲▼]

4 Press ▲ or ▼ to select the desired setting.

5 Press **START/COPY/SET**.

6 Press **MENU**.

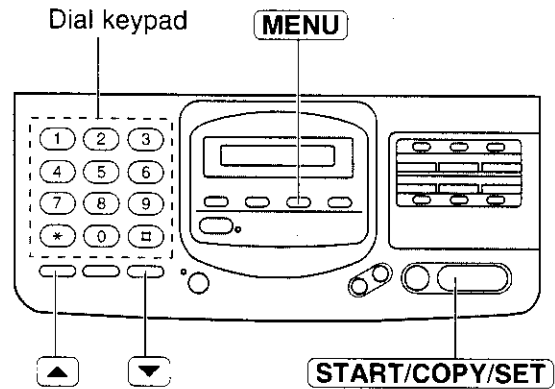

# Setting the fax voice guidance (KX-F2781 only)

With this feature, the voice guidance for transmission, reception and the friendly reception will be heard. If you do not want to hear this guidance, set this feature to OFF.

1 Press **MENU**.

SYSTEM SET UP

2 Press **#**, then **4** **7**.

FAX GUIDANCE

3 Press **START/COPY/SET**.

MODE=ON [▲▼]

4 Press ▲ or ▼ to select the desired setting.

5 Press **START/COPY/SET**.

6 Press **MENU**.

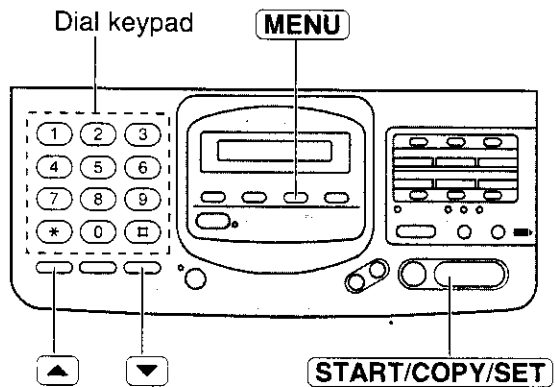



# Changing the display contrast

Use this feature to adjust the brightness of the display.

**NORMAL:** (Pre-selected setting)

**DARKER:** Used when the display contrast is too light.

- 1 Press **MENU**.  
SYSTEM SET UP
- 2 Press **#**, then **3** **9**.  
LCD CONTRAST
- 3 Press **START/COPY/SET**.  
MODE=NORMAL [▲▼]
- 4 Press ▲ or ▼ to select the desired setting.
- 5 Press **START/COPY/SET**.
- 6 Press **MENU**.

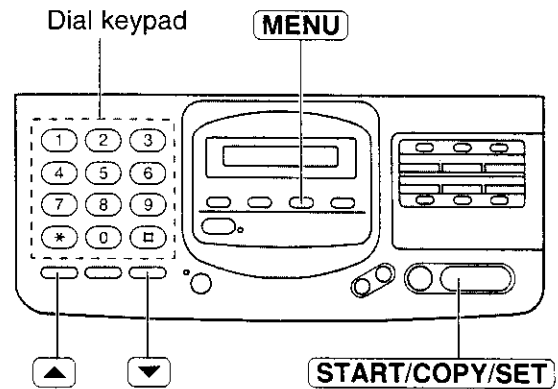

# Setting the handset switch

This unit can work without the handset and handset cradle. When you do not use the handset and cradle, set this feature to NO HANDSET.

**USE HANDSET:** Choose when you use the handset and handset cradle (pre-selected setting).

**NO HANDSET:** Choose when you do not use the handset and handset cradle.

- 1 Press **MENU**.  
SYSTEM SET UP
- 2 Press **#**, then **8** **9**.  
HANDSET SWITCH
- 3 Press **START/COPY/SET**.  
USE HANDSET [▲▼]
- 4 Press ▲ or ▼ to select the desired setting.
- 5 Press **START/COPY/SET**.
- 6 Press **MENU**.

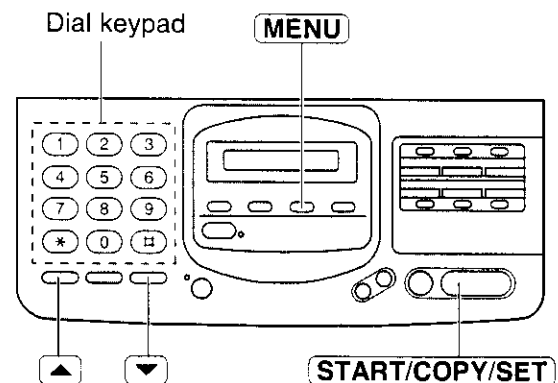

**Note:**

- After setting NO HANDSET, disconnect and connect the power cord again.

# Resetting the advanced features

Use this feature to return the advanced features (see page 67 or 68) to their pre-selected settings.

**1** Press **MENU**.

SYSTEM SET UP

**2** Press **#**, then **8 0**.

SET DEFAULT

**3** Press **START/COPY/SET**.

RESET=NO [▲▼]

**4** Press **▲** or **▼** to select "YES".

RESET=YES [▲▼]

**5** Press **START/COPY/SET**.

RESET OK?

• If this feature is not required, press **STOP**.

**6** Press **START/COPY/SET** again for confirmation.

RESET COMPLETED

**7** Press **MENU**.

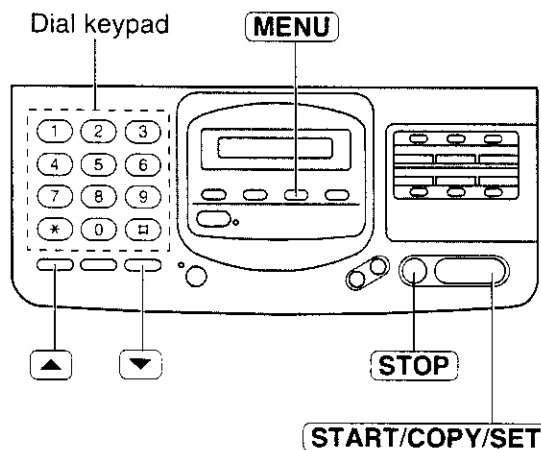

# Summary of user programmable features =====

## For KX-F2581 \_\_\_\_\_

### Basic features

Code	Feature	Selection	Initial setting	Page
#01	SET DATE & TIME	mm/dd/yy hh:mm		12
#02	YOUR LOGO			12
#03	YOUR TELEPHONE NUMBER			14
#04	PRINT TRANSMISSION REPORT	ERROR, ON, OFF	ERROR	70
#05	AUTO RECEIVE MODE	FAX, EXT.TAM	FAX	18
#07	FAX RING COUNT	2-9 rings	2 rings	26
#08	MANUAL RECEIVE MODE	TEL, TEL/FAX	TEL	18
#09	TEL/FAX RING COUNT	2-9 rings	2 rings	28
#12	REMOTE TAM ACTIVATION	ON, OFF	OFF/ID=11	48

### Advanced features

Code	Feature	Selection	Initial setting	Page
#21	LOGO POSITION	OUT, IN	OUT	41
#22	JOURNAL AUTO PRINT	ON, OFF	ON	70
#23	OVERSEAS MODE	ON, OFF	OFF	41
#24	JUNK MAIL PROHIBITOR	ON, OFF	OFF/ID=22	43
#25	DELAYED TRANSMISSION	ON, OFF	OFF	40
#30	SILENT FAX RECOGNITION RING	3-6 rings	3 rings	29
#31	RING DETECTION	ON, OFF	OFF	44
#39	LCD CONTRAST	NORMAL, DARKER	NORMAL	65
#40	SILENT DETECTION	ON, OFF	ON	49
#41	REMOTE FAX ACTIVATION CODE	ON, OFF	ON/ID=*9	42
#46	FRIENDLY RECEPTION	ON, OFF	ON	64
#70	FAX PAGER	ON, OFF	OFF	45
#80	SET DEFAULT	YES, NO	NO	66
#89	HANDSET SWITCH	USE HANDSET, NO HANDSET	USE HANDSET	65

# For KX-F2781

## Basic features

Code	Feature	Selection	Initial setting	Page
#01	SET DATE & TIME	mm/dd/yy hh:mm		12
#02	YOUR LOGO			12
#03	YOUR TELEPHONE NUMBER			14
#04	PRINT TRANSMISSION REPORT	ERROR, ON, OFF	ERROR	70
#05	AUTO RECEIVE MODE	ANS/FAX, FAX	ANS/FAX	18
#06	ANS/FAX RING COUNT	2-9 rings, TOLL SAVER, RINGER OFF	2 rings	25
#07	FAX RING COUNT	2-9 rings	2 rings	26
#08	MANUAL RECEIVE MODE	TEL, TEL/FAX	TEL	18
#09	TEL/FAX RING COUNT	2-9 rings	2 rings	28
#10	RECORDING TIME	VOX (unlimited), 1 minute	VOX	62
#11	REMOTE ANS ID		ID=111	56

## Advanced features

Code	Feature	Selection	Initial setting	Page
#21	LOGO POSITION	OUT, IN	OUT	41
#22	JOURNAL AUTO PRINT	ON, OFF	ON	70
#23	OVERSEAS MODE	ON, OFF	OFF	41
<i>OFF</i> → #24	JUNK MAIL PROHIBITOR	ON, OFF	OFF/ID=22	43
#25	DELAYED TRANSMISSION	ON, OFF	OFF	40
#30	SILENT FAX RECOGNITION RING	3-6 rings	3 rings	29
#31	RING DETECTION	ON, OFF	OFF	44
#39	LCD CONTRAST	NORMAL, DARKER	NORMAL	65
#41	REMOTE FAX ACTIVATION CODE	ON, OFF	ON/ID=*9	42
#42	MESSAGE ALERT	ON, OFF	OFF	62
#43	RECORDING TIME ALERT	ON, OFF	OFF	63
#46	FRIENDLY RECEPTION	ON, OFF	ON	64
#47	FAX VOICE GUIDANCE	ON, OFF	ON	64
#50	MAIL BOX ALERT	ON, OFF	OFF	52
#51	BOX1 PASSWORD		555	50
#52	BOX2 PASSWORD		555	50
#53	BOX3 PASSWORD		555	50
#54	COMMON GREETING MESSAGE RECORDING TIME	16 s, 60 s	16 s	63
#60	COMMON MESSAGE TRANSFER	MESSAGE, PAGER, OFF	OFF	54
#61	MAIL BOX1 MESSAGE TRANSFER	MESSAGE, PAGER, OFF	OFF	54
#62	MAIL BOX2 MESSAGE TRANSFER	MESSAGE, PAGER, OFF	OFF	54
#63	MAIL BOX3 MESSAGE TRANSFER	MESSAGE, PAGER, OFF	OFF	54
#70	FAX PAGER	ON, OFF	OFF	45
#80	SET DEFAULT	YES, NO	NO	66
#89	HANDSET SWITCH	USE HANDSET, NO HANDSET	USE HANDSET	65

# Printing reports and lists

You can print out the following reports and lists from your unit.

**Basic feature list**—provides you with the current settings of the basic features (see page 67 or 68).

**Advanced feature list**—provides you with the current settings of the advanced features (see page 67 or 68).

**Telephone number list**—provides you with phone numbers and their station names which are stored in automatic dialing. Codes in the phone number show;

P: A pause has been entered.

F: A recall has been entered.

[ ]: A secret phone number has been entered. (The telephone number is not printed.)

**Journal report**—keeps records of fax transmissions and receptions. This report will be printed automatically after every 35 fax communications, but can be printed manually. You can change the setting of the journal auto print feature (see page 70).

**Transmission report**—provides you with a printed record of the fax transmission result (see pages 70 and 71).

## How to print reports and lists

1 Press **MENU** <sup>A number of times,</sup> until the following is displayed.

PRINT LIST

2 For the basic feature list, press **#**, then **1**.

BASIC LIST

For the advanced list, press **#**, then **2**.

ADVANCED LIST

For the telephone number list, press **#**, then **3**.

TEL NO. LIST

For the journal report, press **#**, then **4**.

JOURNAL REPORT

3 Press **START/COPY/SET** to start printing.

•To interrupt printing, press **STOP**.

4 After printing, press **MENU**.

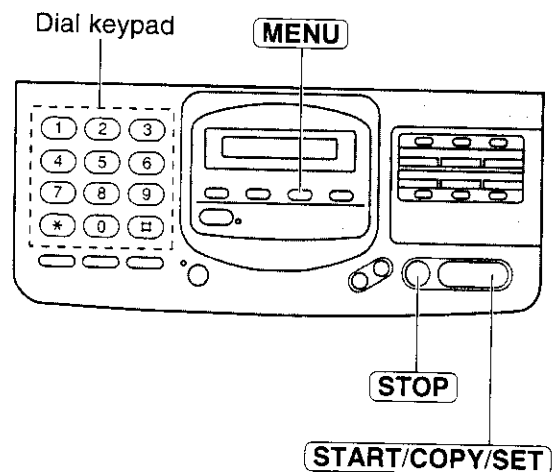

## Setting the transmission report printing

One of the following choices is available.

**ERROR:** The transmission report will print out only when fax transmission fails (pre-selected setting).

**ON:** The report will always print out, indicating whether fax transmission is successful or not.

**OFF:** The report will not print.

**1** Press **MENU**.

SYSTEM SET UP

**2** Press **#**, then **0** **4**.

TX-REPORT MODE

**3** Press **START/COPY/SET**.

MODE=ERROR [▲▼]

**4** Press **▲** or **▼** to select the desired setting.

**5** Press **START/COPY/SET**.

**6** Press **MENU**.

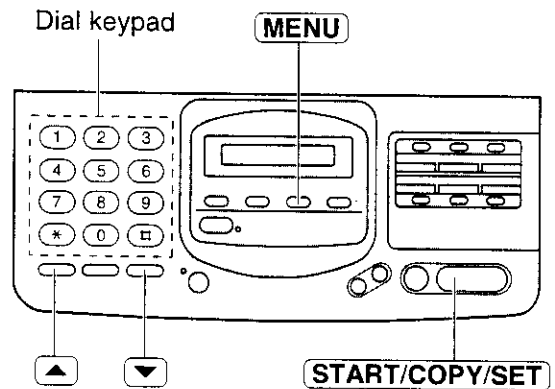

## Setting journal auto print

This unit will automatically print a journal report after every 35 fax communications. After printing, the journal memory will be erased and only subsequent activity will be recorded.

When this feature is deactivated, the unit will store the records of the last 35 fax communications, but the unit will not print the journal report automatically.

**1** Press **MENU**.

SYSTEM SET UP

**2** Press **#**, then **2** **2**.

AUTO JOURNAL

**3** Press **START/COPY/SET**.

MODE=ON [▲▼]

**4** Press **▲** or **▼** to select the desired setting.

**5** Press **START/COPY/SET**.

**6** Press **MENU**.

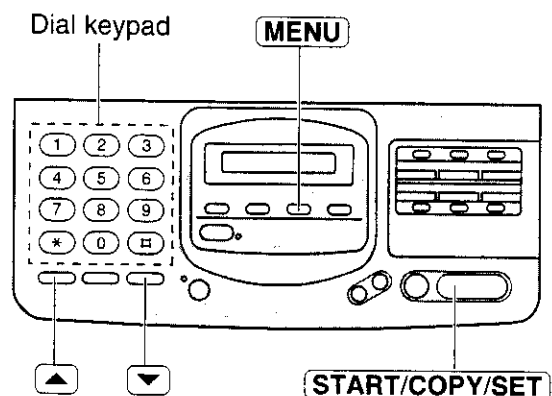

## Sample of journal report

[ JOURNAL ]							JAN. 25 1997 05:22PM	
NO.	OTHER FACSIMILE	START TIME	USAGE TIME	MODE	PAGES	RESULT	*CODE	
01	1234567	JAN. 21 02:14PM	00'25	TX	01	OK		
02	9998765	JAN. 21 02:17PM	00'38	TX	02	OK		
03	2121444	JAN. 21 02:18PM	00'28	RX	01	OK		
04	55556677	JAN. 22 10:35AM	00'58	TX	03	COMMUNICATION ERROR	(43)	
05			01'50	TX	05	OK		
				RX	03	OK		

## Sample of transmission report

[ XMT REPORT ]							JAN. 20 1997 01:19PM	
NO.	OTHER FACSIMILE	START TIME	USAGE TIME	MODE	PAGES	RESULT	*CODE	
01	1234567	JAN. 20 01:18PM	00'51	TX	00	COMMUNICATION ERROR	(43)	

Communication result (see below.)

Error code (for service personnel use only)

## Communication result on the report

When a problem has occurred, one of the following messages will be printed on the transmission and journal reports.

PRINTED MESSAGE	CODE	MEANING
COMMUNICATION ERROR	41-47 FF	A transmission or reception error occurred. Try again or check with the other party.
DOCUMENT JAMMED	—	The document is jammed. Remove the jammed document (see page 77).
JUNKMAIL PROH. REJECT	—	The junk mail prohibitor of your unit rejected fax reception (see page 43).
NO DOCUMENT	—	The document was not fed into the unit properly. Try again.
NO RESPONSE	—	The receiving unit was busy or ran out of recording paper. Try again.
PAPER JAMMED	—	The recording paper is jammed. Clear the jammed paper (see page 76).
PAPER OUT	—	The unit ran out of recording paper. Install a recording paper roll (see page 10).
PRESSED THE STOP KEY	—	The STOP button was pressed, and fax communication was cancelled.
PRINTER OVERHEATED	—	Printer was overheated. Let the unit cool down.
THE COVER WAS OPENED	—	The back lid was open. Close it and try again.
OK	—	Fax communication was successful.

# Error messages on the display

If the unit detects a problem, the following messages will appear on the display.

DISPLAY MESSAGE	CAUSE & REMEDY
CALL SERVICE	<ul style="list-style-type: none"> <li>There is something wrong with the unit. Contact your service personnel.</li> </ul>
CHECK COVER	<ul style="list-style-type: none"> <li>The back lid is open. Close it.</li> </ul>
CHECK CRADLE	<ul style="list-style-type: none"> <li>The handset and handset cradle have been removed when you connect the power cord.               <ul style="list-style-type: none"> <li>—When you want to use the handset and handset cradle, install the handset cradle correctly (see page 9).</li> <li>—When you do not use the handset and handset cradle, set the handset switch to NO HANDSET (see page 65). Then, disconnect and connect the power cord again.</li> </ul> </li> </ul>
CHECK DOCUMENT	<ul style="list-style-type: none"> <li>The document is not fed into the unit properly. Reinsert the document. If the misfeeding occurs frequently, clean the document feeder rollers inside the unit (see page 78). If the problem remains, adjust the feeder pressure (see page 77).</li> </ul>
CHECK MEMORY	<ul style="list-style-type: none"> <li>Memory (phone numbers, parameters, etc.) has been erased. Re-program.</li> </ul>
FAX IN MEMORY	<ul style="list-style-type: none"> <li>The unit has documents in memory. Install a new recording paper roll (see page 10) or clear the jammed paper (see page 76).</li> </ul>
MEMORY FULL	<ul style="list-style-type: none"> <li>There is no room left in memory to record a message. Erase some or all of the messages (see pages 31 and 52).</li> <li>The memory is full of received documents. Install a new recording paper roll (see page 10) or clear the jammed paper (see page 76).</li> </ul>
NO RESPONSE	<ul style="list-style-type: none"> <li>The receiving unit is busy or ran out of recording paper. Try again.</li> </ul>
NO TEL GREETING	<ul style="list-style-type: none"> <li>The TEL/FAX greeting message has not been recorded. Record a greeting message (see page 60).</li> </ul>
OUT OF PAPER	<ul style="list-style-type: none"> <li>The unit ran out of recording paper. Install a new recording paper roll (see page 10).</li> </ul>
PAPER JAMMED	<ul style="list-style-type: none"> <li>A recording paper jam occurred. Clear the jammed paper (see page 76).</li> </ul>
POLLING ERROR	<ul style="list-style-type: none"> <li>The other fax machine does not provide the polling function. Check with the other party.</li> </ul>
REDIAL TIME OUT	<ul style="list-style-type: none"> <li>The receiving unit is busy or ran out of recording paper. Try again.</li> </ul>
REMOVE DOCUMENT	<ul style="list-style-type: none"> <li>The document is jammed. Remove the jammed document (see page 77).</li> <li>Attempted to transmit a document longer than 600 mm (23<sup>5</sup>/<sub>8</sub>" ). Press the STOP button and remove the document (see page 77). Divide the document into two or more sheets and try again.</li> </ul>
TRANSMIT ERROR	<ul style="list-style-type: none"> <li>A transmission error occurred. Try again.</li> </ul>
UNIT OVERHEATED	<ul style="list-style-type: none"> <li>The unit is too hot. Let the unit cool down.</li> </ul>



# Before requesting help

## General

PROBLEM	CAUSE & REMEDY
I cannot make and receive calls.	<ul style="list-style-type: none"> <li>•The power cord or telephone line cord is not connected. Check the connections (see page 11).</li> </ul>
I cannot make calls.	<ul style="list-style-type: none"> <li>•The dialing mode setting is wrong. Check the selector (see page 11).</li> </ul>
The unit does not work.	<ul style="list-style-type: none"> <li>•Disconnect the unit from the telephone line and connect to a known working phone. If the working phone operates properly, call your service centre to have the unit repaired. If the working phone does not operate properly, contact your telephone company.</li> </ul>
The unit does not ring.	<ul style="list-style-type: none"> <li>•The ringer volume is set to OFF. Adjust it to a suitable level (see page 15).</li> </ul>
The REDIAL/PAUSE button does not function properly.	<ul style="list-style-type: none"> <li>•If this button is pressed during dialing, a pause will be inserted. If this button is pressed immediately after obtaining a dial tone, the last number dialed will be redialed.</li> </ul>
During programming, I cannot enter the activation code or the prohibitor ID.	<ul style="list-style-type: none"> <li>•Whole or part of the number is the same as another code or ID. Change the number (see pages 42, 43, 50 and 56).</li> </ul>

## Fax Transmission

PROBLEM	CAUSE & REMEDY
The other party complains that letters on their received document are distorted.	<ul style="list-style-type: none"> <li>•If your line has special telephone services such as call waiting, the service may have been activated during fax transmission. Connect the unit to a line that does not have such services.</li> <li>•An extension telephone on the same line is off the hook. Hang up and try again.</li> </ul>
The other party complains that dirty patterns or black lines appear on their received documents.	<ul style="list-style-type: none"> <li>•The glass or rollers are dirty. Clean them (see page 78).</li> </ul>
I cannot make an international fax call.	<ul style="list-style-type: none"> <li>•Use the overseas transmission mode (see page 41).</li> <li>•Add two pauses at the end of the phone number (see page 38).</li> </ul>

## Fax Reception

PROBLEM	CAUSE & REMEDY
I cannot receive documents automatically.	<ul style="list-style-type: none"> <li>•The receive mode is set to TEL mode. Set to the ANS/FAX, TEL/FAX, FAX or EXT.TAM mode.</li> <li>•The time to answer the call may be too long. Decrease the number of rings (see pages 25, 26 and 28).</li> <li>•The greeting message is too long. Shorten the message (see page 60).</li> <li>•The junk mail prohibitor is set to on (see page 43).</li> </ul>
The recording image is faint.	<ul style="list-style-type: none"> <li>•The sender transmitted a faint document. Request them to transmit a clearer copy of the document.</li> </ul>
The received document is blank.	<ul style="list-style-type: none"> <li>•The recording paper roll is installed incorrectly. Make sure that the shiny side of the paper is facing down and re-install the paper (see page 10).</li> </ul>

## Operation in EXT.TAM mode (For KX-F2581)

PROBLEM	CAUSE & REMEDY
I cannot receive documents automatically.	<ul style="list-style-type: none"> <li>•Your greeting message is too long. Shorten it (up to 10 seconds).</li> <li>•There are too many rings on the answering machine. Set the number of rings to less than 4.</li> <li>•The silent detection feature is deactivated. Activate this feature (see page 49).</li> </ul>
I cannot receive voice messages.	<ul style="list-style-type: none"> <li>•Check that the answering machine is turned on and connected to the facsimile unit properly (see page 46).</li> <li>•Set the number of rings on the answering machine to less than 4.</li> </ul>
I cannot retrieve voice messages on the answering machine from a remote location.	<ul style="list-style-type: none"> <li>•The remote access code on your answering machine is the same as the remote fax activation code or the junk mail prohibitor ID on the facsimile unit. Set a different number for each code/ID.</li> <li>•Your remote TAM activation code is not programmed correctly. Program the same code as on the answering machine (see page 48).</li> </ul>
The greeting message on your answering machine is interrupted halfway and the caller cannot leave a voice message.	<ul style="list-style-type: none"> <li>•Silent pause in the greeting messages is too long. Shorten it to less than 4 seconds.</li> </ul>
I pressed the remote access code to access the answering machine remotely, but the line was disconnected.	<ul style="list-style-type: none"> <li>•The code may include “#” which is used for certain features provided by the telephone company. Change the code on the answering machine not to include “#”. Then program the same code into the facsimile unit (see page 48).</li> </ul>

## Answering Device (For KX-F2781)

PROBLEM	CAUSE & REMEDY
No voice messages have been recorded in the ANS/FAX mode.	●The memory is full. Erase some or all of the messages (see pages 31, 52 and 58).
I cannot retrieve recorded messages from a remote phone.	●Make sure that you use the remote operation ID correctly (see page 56).
Messages in the mailbox do not play back.	●The mailbox password is wrong. Enter the correct password (see page 50).

## Copying

PROBLEM	CAUSE & REMEDY
A dirty pattern or a black line appears on the copied documents.	●The glass or rollers are dirty. Clean them (see page 78).
The copied document is blank.	●The recording paper roll is installed incorrectly. Make sure that the shiny side of the paper is facing down and re-install the paper (see page 10).

## If a power failure occurs

- This unit does not function during a power failure.
- The memory contents will not be erased.
- If the programmed start time has passed during a power failure, delayed transmission will be attempted after power is restored.

# Clearing a recording paper jam

If the unit does not eject any recording paper during reception or copying, the recording paper has jammed. Remove the jammed paper as shown below.

- 1** Open the back lid by lifting up the tabs located on both sides, and press the green lever to release the paper cutter.

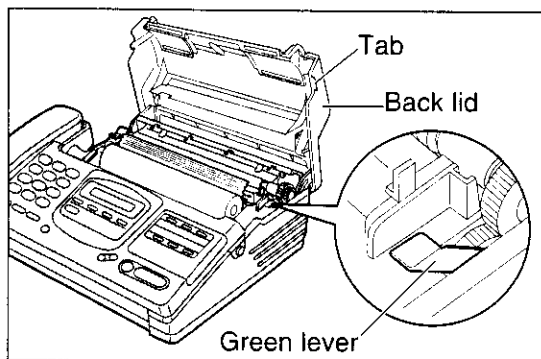

- 2** Pull up the transparent guide and remove the piece of paper.
  - If the transparent guide is not pulled up, press the green lever again.

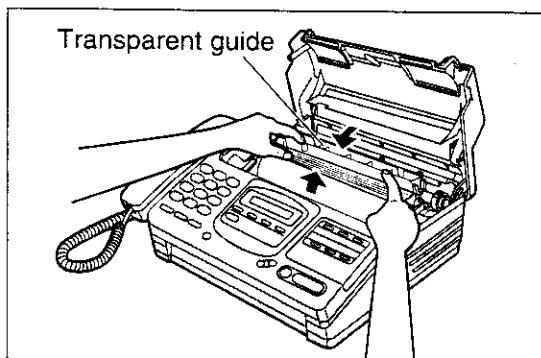

- 3** Replace the transparent guide and recording paper roll in the proper direction, and insert the leading edge of the paper between the recording paper roller and the silver plate.
  - Make sure that there is no slack in the paper roll.

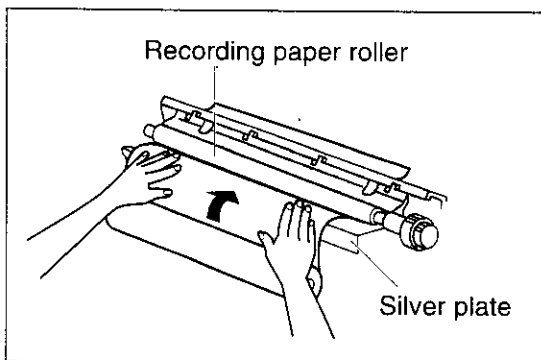

- 4** Close the back lid by gently pressing down on both ends.

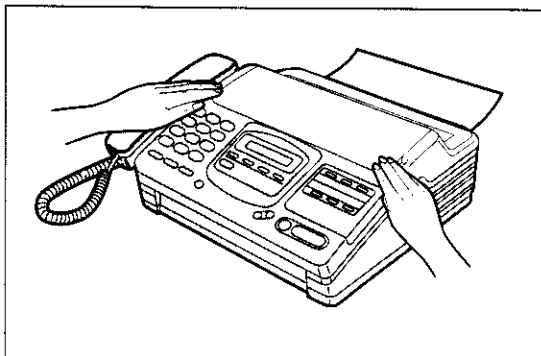

# Clearing a document jam

If the unit does not release an original document during feeding, remove it as shown below.

- 1** Open the front lid by pressing the front lid open button.
- 2** Remove the jammed document.
- 3** Close the front lid by gently pressing down on both ends.

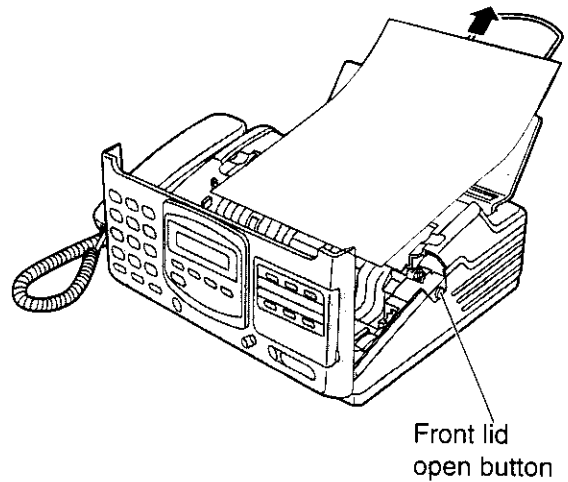

# Adjusting the feeder pressure

No feeding or multiple feeding occurs frequently, adjust the feeder pressure.

- 1** Open the front lid by pressing the front lid open button.
- 2** Shift the position of the lever by using an instrument with a pointed end, like a clip or ball-point pen.  
  
Position A: Select this when documents do not feed.  
Position B: Standard position (pre-selected)  
Position C: Select this when documents multiple feed.
- 3** Close the front lid by gently pressing down on both ends.

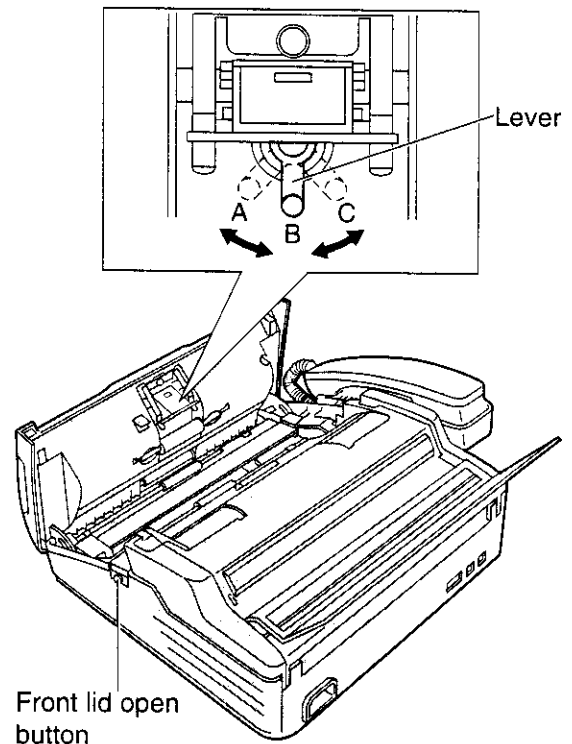

# Removing the handset cradle

To save space or to use the unit mainly for faxes, you may remove the handset cradle.

- 1 Set the handset switch to NO HANDSET (see page 65).
- 2 Pull the hooks to the right in the order as shown, while lifting up the handset cradle.
- 3 Disconnect and connect the power cord again.

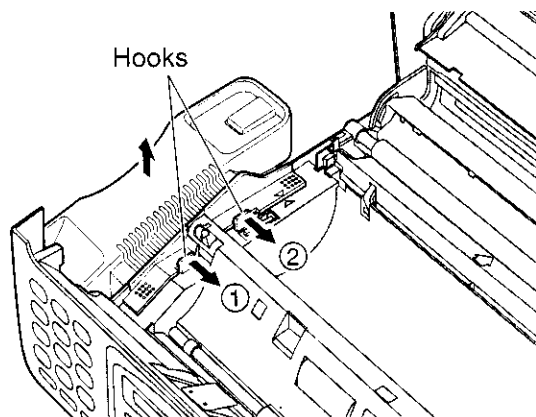

## Caution:

- If the handset and handset cradle have been removed when you connect the power cord, an alarm will sound and the following message will be displayed.

CHECK CRADLE

Set the handset switch to NO HANDSET (see page 65).

# Cleaning the inside of the unit

If misfeeding occurs frequently or dirty patterns or black bands appear on a copied or transmitted document, clean the document feeder rollers, sub roller, rubber flap, white plate and glass.

- 1 Disconnect the power cord and the telephone line cord.
- 2 Open the front lid by pressing the front lid open button.
- 3 Clean the document feeder rollers and sub roller with a cloth moistened with isopropyl rubbing alcohol, and let dry thoroughly.
- 4 Clean the rubber flap with a cotton swab moistened with isopropyl rubbing alcohol, and let dry thoroughly.
- 5 Clean the white plate and glass with a soft dry cloth.
- 6 Close the front lid by gently pressing down on both ends.
- 7 Connect the power cord and the telephone line cord.

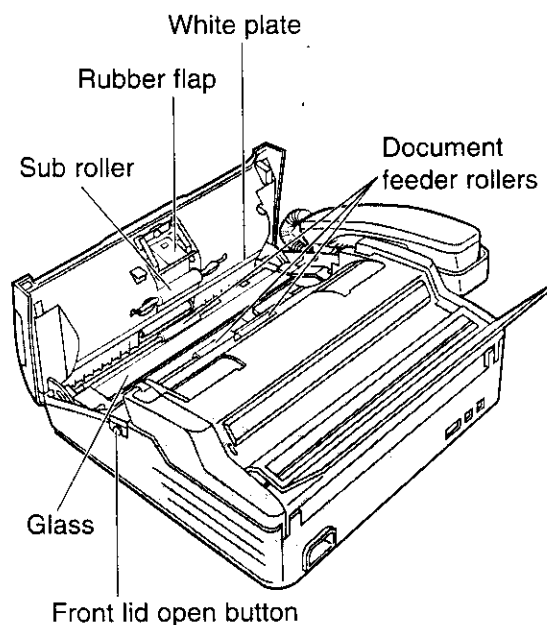

## Caution:

- Do not use paper products (such as paper towels or tissues) to clean the inside of the unit.



# Index

- A** ANS/FAX mode ..... 17, 24  
 ANS/FAX ring count ..... 25  
 Answering device volume ..... 15  
 AUTO RECEIVE button ..... 16, 17  
 AUTO RECEIVE mode ..... 16, 17  
 Automatic dialing ..... 34
- C** Call counter ..... 31  
 Caller's recording time ..... 62  
 CHECK button ..... 61  
 Cleaning ..... 78  
 COPY button ..... 30
- D** Date and time ..... 12  
 Delayed transmission ..... 40  
 DELETE key ..... 13  
 Dialing mode ..... 11  
 DIRECTORY button ..... 35, 36  
 Display contrast ..... 65
- E** Electronic telephone directory ..... 36  
 ERASE button ..... 31, 61  
 Error message ..... 72  
 EXT.TAM mode ..... 16, 46
- F** Facsimile telephone number ..... 14  
 FaxAbility ..... 44  
 Fax auto redial ..... 21  
 FAX mode ..... 16, 17, 26  
 Fax pager ..... 45  
 FAX ring count ..... 26  
 Fax voice guidance ..... 64  
 Fax voice guidance volume ..... 15  
 Feeder pressure ..... 77  
 Friendly reception ..... 23, 64
- G** Greeting messages ..... 60
- H** Handset switch ..... 65  
 Handset volume ..... 15  
 HELP button ..... 11
- I** INSERT key ..... 13
- J** Journal auto print ..... 70  
 Journal report ..... 69, 71  
 Junk mail prohibitor ..... 43
- L** Logo ..... 12  
 Logo print position ..... 41  
 LOWER key ..... 34, 35
- M** MAIL BOX button ..... 51  
 Mailbox alert ..... 52  
 Mailbox password ..... 50  
 MANUAL RECEIVE mode ..... 16, 17  
 MEMO/2WAY REC button ..... 33  
 Message alert ..... 62  
 Message transfer ..... 53  
 MUTE button ..... 19
- N** NEW MSGS. PLAY BACK button ..... 31
- O** Overseas transmission mode ..... 41
- P** Pager call ..... 53  
 PAUSE button ..... 38  
 Polling ..... 39  
*Printing* ..... 69 & 70
- Q** QUICK button ..... 32
- R** REC button ..... 60  
 RECALL button ..... 38  
 Recording time alert ..... 63  
 Recording time for ANS/FAX greeting  
 message ..... 63  
 REDIAL button ..... 38  
 Remote fax activation code ..... 42  
 Remote operation ID ..... 56  
 Remote TAM activation ID ..... 48  
 REPEAT button ..... 32  
 RESOLUTION button ..... 20  
 Ring pattern detection ..... 44  
 Ringer volume ..... 15
- S** SECRET key ..... 34  
 SELECT button ..... 60  
 Set default ..... 66  
 Silent detection ..... 49  
 Silent fax recognition ring ..... 29  
 SKIP button ..... 32  
 SLOW button ..... 32  
 SPACE key ..... 13  
 Speaker volume ..... 15  
 SP-PHONE button ..... 19
- T** TEL mode ..... 16, 17  
 TEL/FAX mode ..... 16, 17, 27  
 TEL/FAX ring count ..... 28  
 Telephone number list ..... 69  
 Toll saver ..... 25  
 TONE button ..... 38  
 Transmission report ..... 69, 70
- V** Voice contact ..... 37  
 Voice time/day stamp ..... 31  
 VOLUME button ..... 15



## One-touch dialer list

Direct Call Station No.	Name/Phone No.	Direct Call Station No.	Name/Phone No.
1		6 (LOWER 1)	
2		7 (LOWER 2)	
3		8 (LOWER 3)	
4		9 (LOWER 4)	
5		10 (LOWER 5)	

## Speed dialer list

Station No.	Name/Phone No.	Station No.	Name/Phone No.
00		25	
01		26	
02		27	
03		28	
04		29	
05		30	
06		31	
07		32	
08		33	
09		34	
10		35	
11		36	
12		37	
13		38	
14		39	
15		40	
16		41	
17		42	
18		43	
19		44	
20		45	
21		46	
22		47	
23		48	
24		49	

## One-touch dialer list

Direct Call Station No.	Name/Phone No.	Direct Call Station No.	Name/Phone No.
1		6 (LOWER 1)	
2		7 (LOWER 2)	
3		8 (LOWER 3)	
4		9 (LOWER 4)	
5		10 (LOWER 5)	

## Speed dialer list

Station No.	Name/Phone No.	Station No.	Name/Phone No.
00		25	
01		26	
02		27	
03		28	
04		29	
05		30	
06		31	
07		32	
08		33	
09		34	
10		35	
11		36	
12		37	
13		38	
14		39	
15		40	
16		41	
17		42	
18		43	
19		44	
20		45	
21		46	
22		47	
23		48	
24		49	